

DEROTATEUR

BOITE DE COMMUTATION

avril 2004

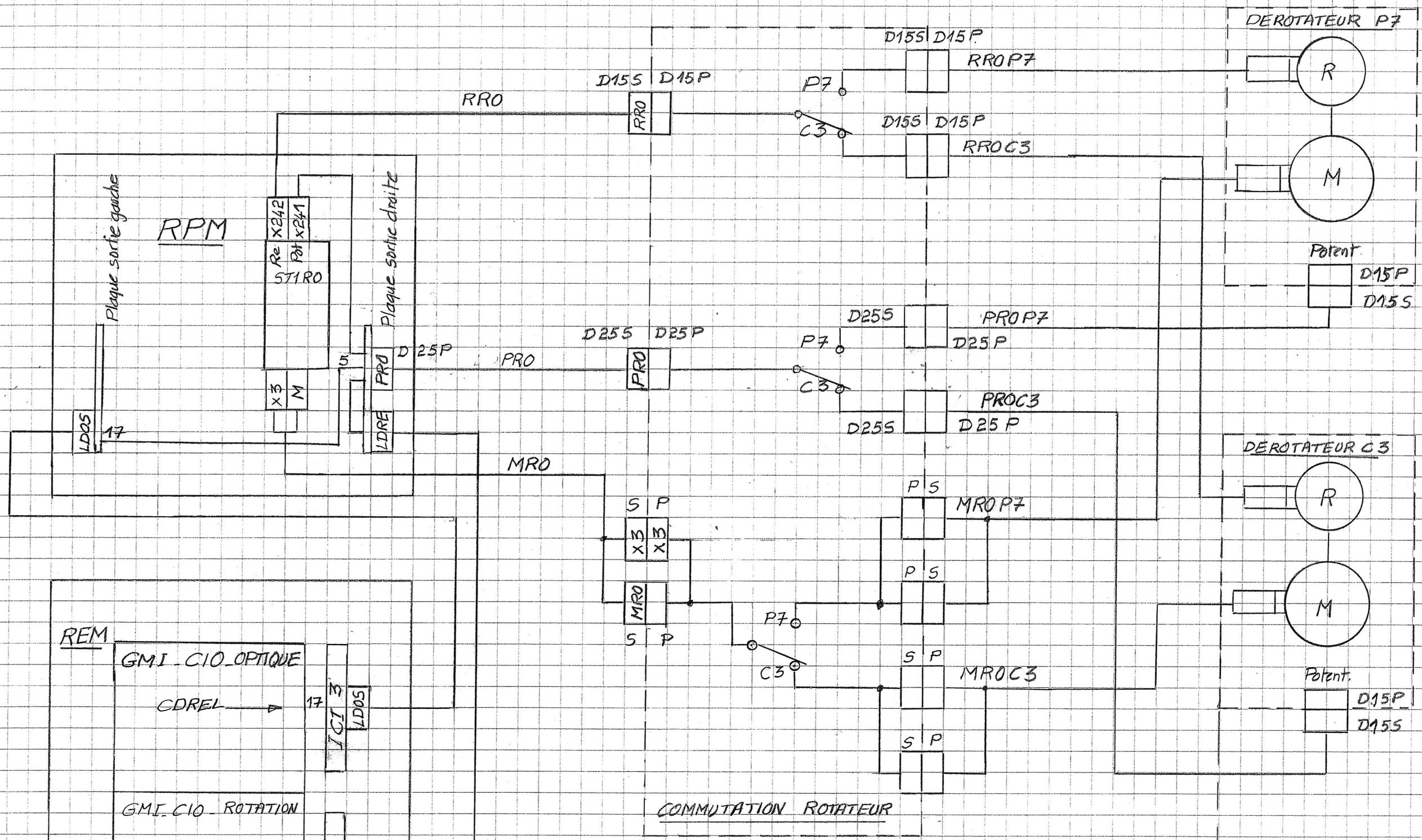

Longueur cables boîte de commutation → Dérotateur P7 C3 = 11m
 Longueur cables " " → RPM = 2,5m

R	Observations :	Appareil No:	A3		
C	Modifications:	Sheet No:			
L	. SCHEMA ENSEMBLE	Ech.	Dessine	Tartarat	
D	. COMMUTATION ROTATEUR P7 C3	Date	13/5/2003		
Q	. T5	Page	Etude	E. Ischi	
.		/	Revise		
.	OBSERVATOIRE DE GENEVE				
.	Tel. (022) 755 26 11 / Fax. (022) 755 39 83				

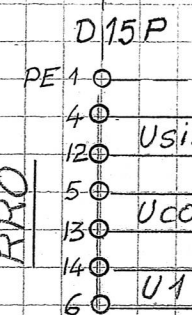
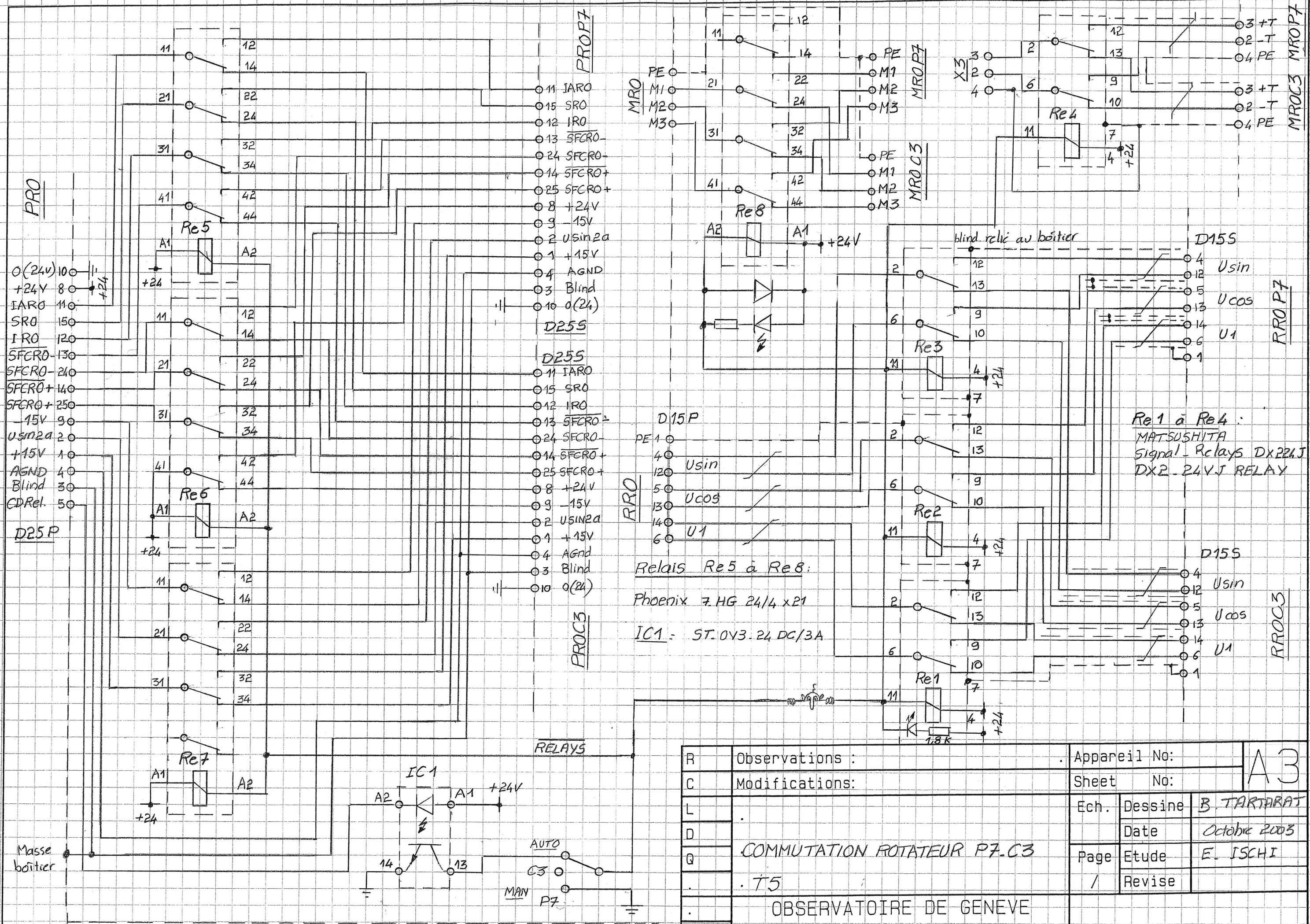

Relais Re5 à Re8:
 Phoenix 7.HG 24/4 x21
 IC1: ST.0V3.24 DC/3A

Re1 à Re4:
 MATSUSHITA
 Signal - Relays DX224J
 DX2-24VJ RELAY

R	Observations :	Appareil No:	A3	
C	Modifications:	Sheet No:		
L	.	Ech.	Dessine	B. TARTARAT
D	.		Date	Octobre 2003
Q	COMMUTATION ROTATEUR P7.C3	Page	Etude	E. ISCHI
.	. T5	/	Revise	
.	OBSERVATOIRE DE GENEVE			
.	Tel. (022) 755 26 11 / Fax. (022) 755 39 83			

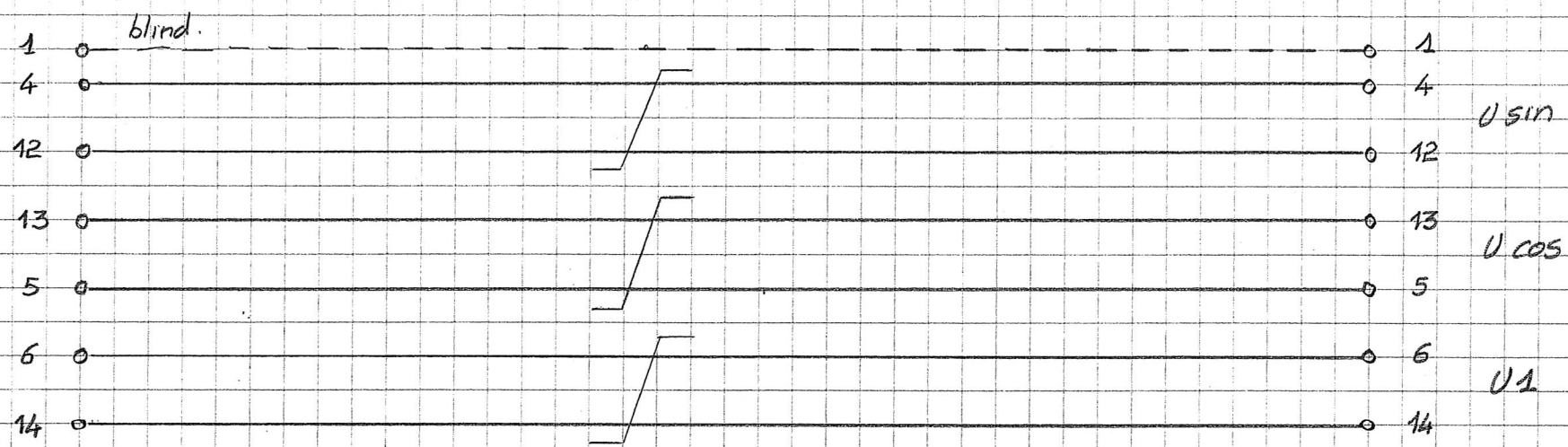

D15P
RPM
ST1 R0 X P42

3 x 2 x 0,25 blindé.
L = 2,5 m.

D155
Boîte Commutation
RRO

R	Observations :	Appareil No:		A3
C	Modifications:	Sheet No:		
L	. RPM → Boîte de commutation	Ech.	Dessine	Tartaral
D	. CABLE RESOLVER RRO		Date	26/5/03
Q	. COMMUTATION ROTATEUR P7.C3	Page	Etude	
		/	Revise	
OBSERVATOIRE DE GENEVE				
Tel. (022) 755 26 11 / Fax. (022) 755 39 83				

D15P

Cable 3x2x0,25 blindé

Connect. Fem. Atlas Copco
N° 9032011109

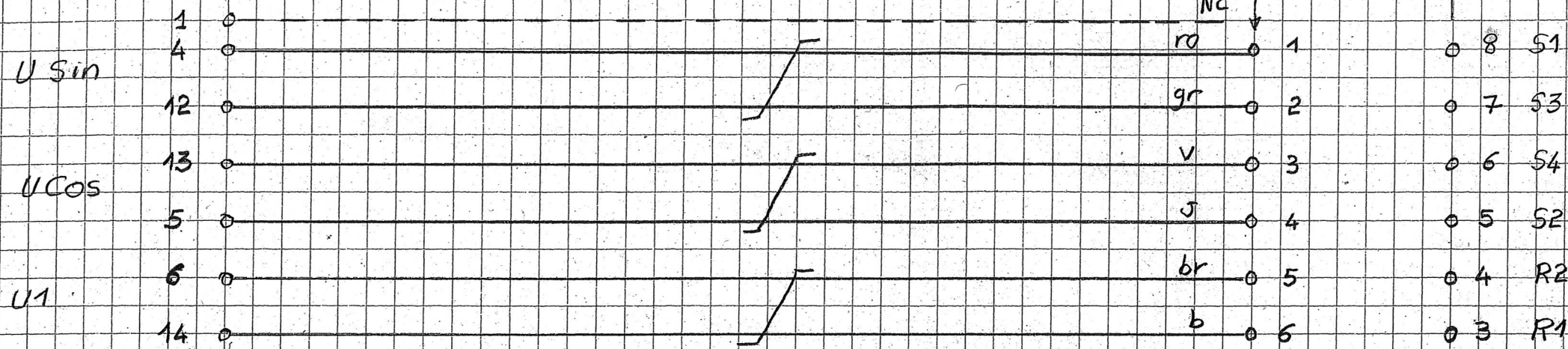

Connect. Résolveur sur Moteur

11 m. dérotateur



La numérotation de la fiche cable ne correspond pas à la numérotation de la prise sur le moteur!

FEEDBACK CONNECTOR

ACC REF.	PIN	FUNCTION	WIRE COLOUR
	1		
	2		
A	3	ROTOR R1	RED/WHITE
B	4	ROTOR R2	BLACK/WHITE
E	5	STATOR 2nd PHASE S2	BLUE
F	6	STATOR 2nd PHASE S4	YELLOW
C	7	STATOR 1st PHASE S3	BLACK
D	8	STATOR 1st PHASE S1	RED
	9		
	10		
	11		
	12		

Connect. sur moteur vu de face

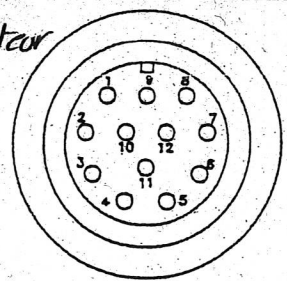

INTERCONNECTRON
S'EE A 12A MR EN 000 02

R	Observations :	Appareil No:	A3
C	Modifications:	Sheet No:	A3
L	CABLE RESOLVEUR RROP7	Ech. Dessine	Tortard
D		Date	1/11/2001
Q	DEROTATEUR P7	Page Etude	
		/ Revise	
OBSERVATOIRE DE GENEVE			
Tel (022) 755 26 11 / Fax. (022) 755 39 83			

D15P

Cable 3x2x0,25 blindé

Connect. Fem. Atlas Copco
N° 9032011109

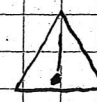
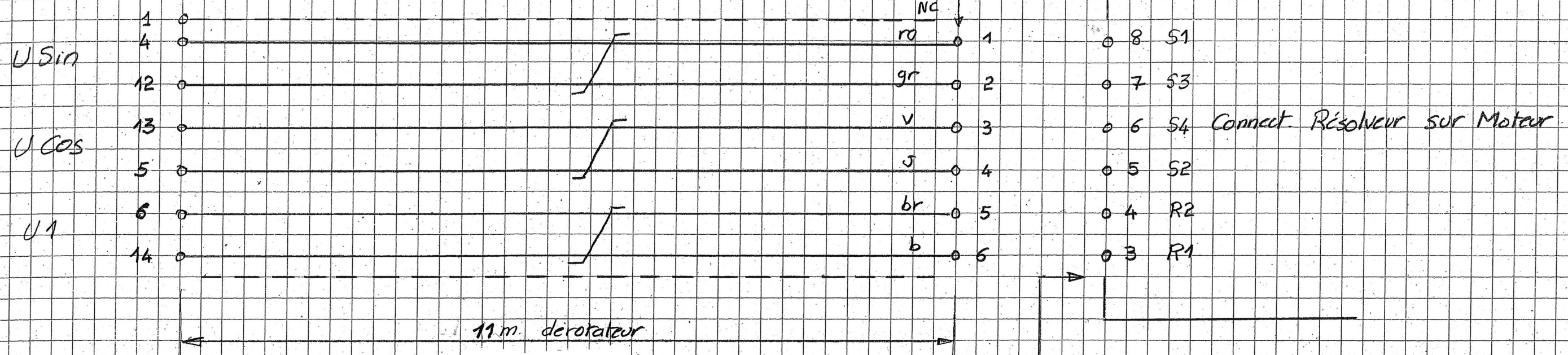

La numérotation de la fiche cable ne correspond pas à la numérotation de la prise sur le moteur!

FEEDBACK CONNECTOR

ACC REF.	PIN	FUNCTION	WIRE COLOUR
	1		
	2		
A	3	ROTOR R1	RED/WHITE
B	4	ROTOR R2	BLACK/WHITE
E	5	STATOR 2nd PHASE S2	BLUE
F	6	STATOR 2nd PHASE S4	YELLOW
C	7	STATOR 1st PHASE S3	BLACK
D	8	STATOR 1st PHASE S1	RED
	9		
	10		
	11		
	12		

Connect. sur moteur vu de face

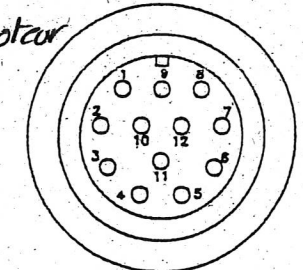

INTERCONNECTEUR
S EE A 12A MR EN 000 02

R	Observations :	Appareil No:	A3
C	Modifications:	Sheet No:	
L	Boîte de commutation → Mot. Derot C3	Ech. Dessine	Tortorati
D	CABLE RESOLVER RROC3	Date	1/11/2001
Q	DEROTATEUR C3	Page Etude	
		/ Revise	
OBSERVATOIRE DE GENEVE			
Tel. (022) 755 26 11 / Fax. (022) 755 39 83			

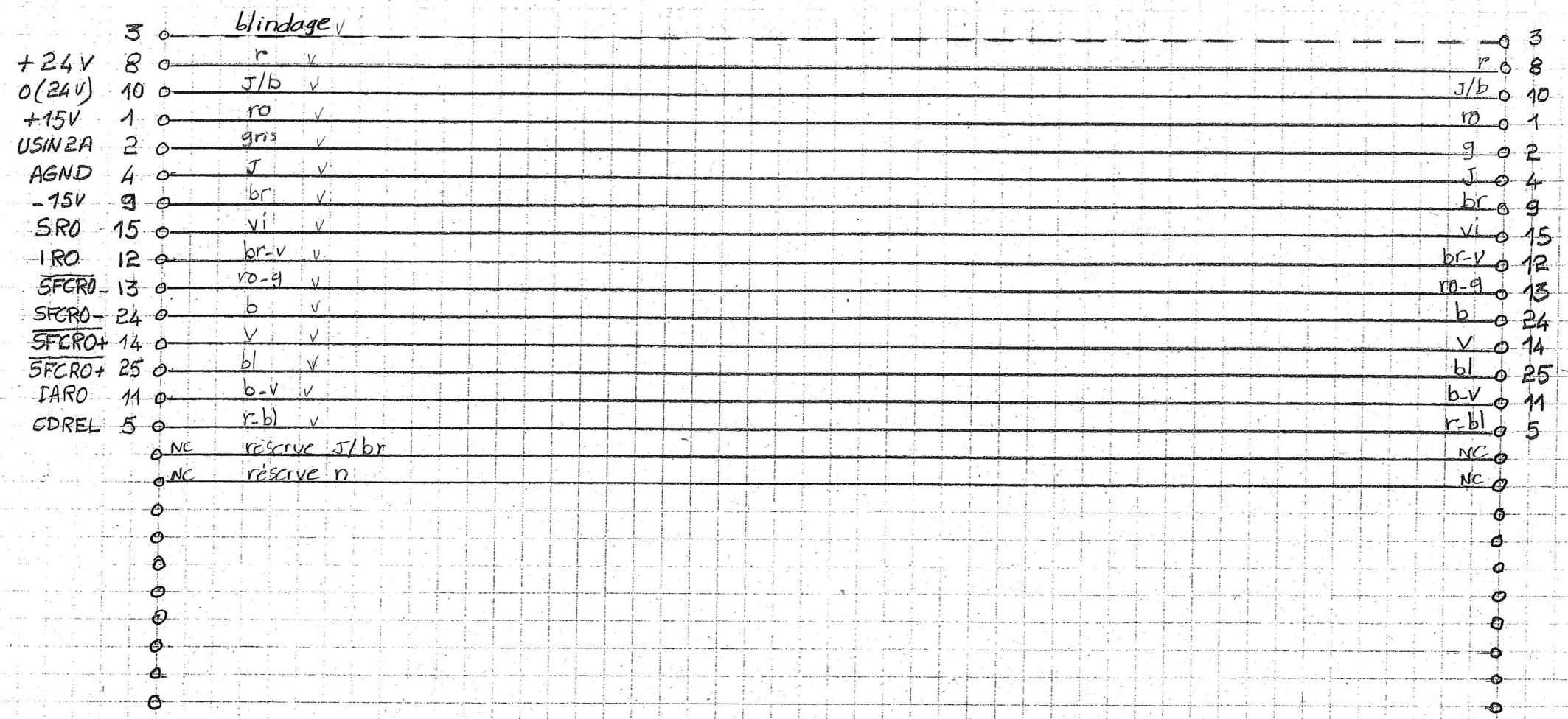

D25P

PRO

RPM Plaque sortie droite

Cable 16 x 0,25 blindé
2,5 metres

D25S

PRO

Boite de commutation

R	Observations :	Appareil No:	A3
C	Modifications:	Sheet No:	
L	Cable PRO	Ech.	Dessine Tartarat
D		Date	27/05/03
Q		Page	Etude
	COMMUTATION ROTATEUR P7.C3	/	Revise
	OBSERVATOIRE DE GENEVE		
	Tel. (022) 755 26 11 / Fax. (022) 755 39 83		

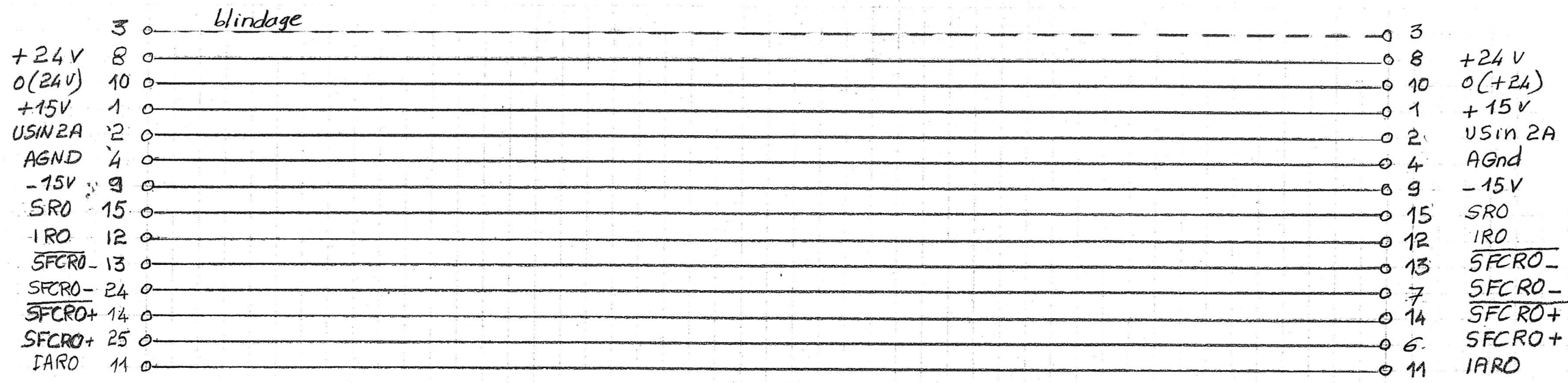

PROP7
D25P

Boîte de commutation

Cable 16 x 0,25 blindé
L = 11m

D155
Boîte de jonction rotateur (BJRO)

R	Observations :	Appareil No:		A3
C	Modifications:	Sheet No:		
L	. CABLE PROP7 . COMMUTATION ROTATEUR P7.C3 . T5	Ech.	Dessine	Tartarat
D			Date	22/04/2004
Q		Page	Etude	
.		/	Revise	
.	OBSERVATOIRE DE GENEVE			
.	Tel. (022) 755 26 11 / Fax. (022) 755 39 83			

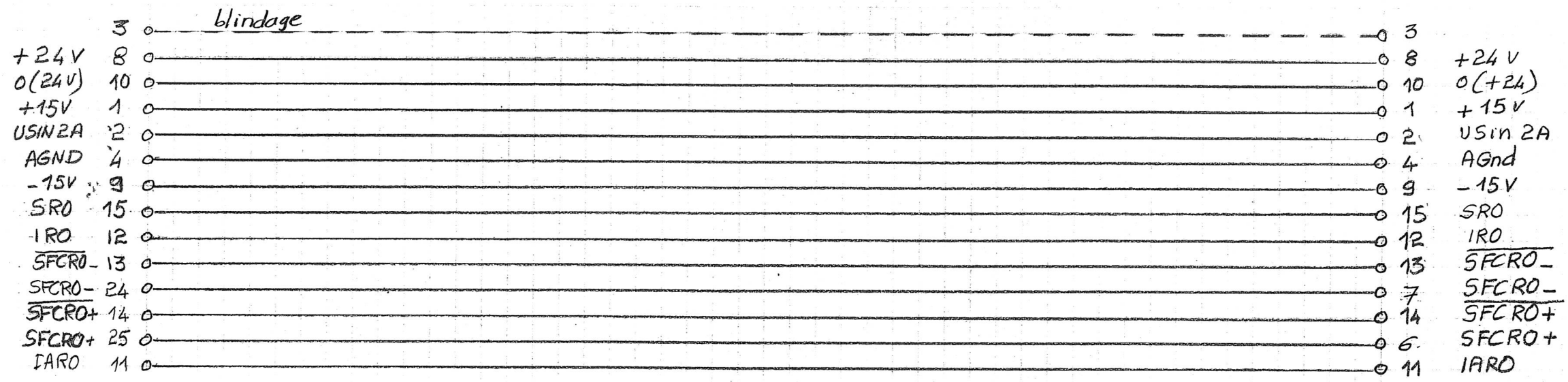

PROC3
D25P
Boîte de commutation

Cable 16 x 0,25 blindé
L = 11m

D155
Boîte de jonction rotateur (BJRO)

R	Observations :	Appareil No:		
C	Modifications:	Sheet No:		A
L	CABLE PROC3	Ech.	Dessine	Tartarat
D	COMMUTATION ROTATEUR P7.C3		Date	22/04/2004
Q	T5	Page	Etude	
		/	Revise	
OBSERVATOIRE DE GENEVE				
Tel. (022) 755 26 11 / Fax. (022) 755 39 83				

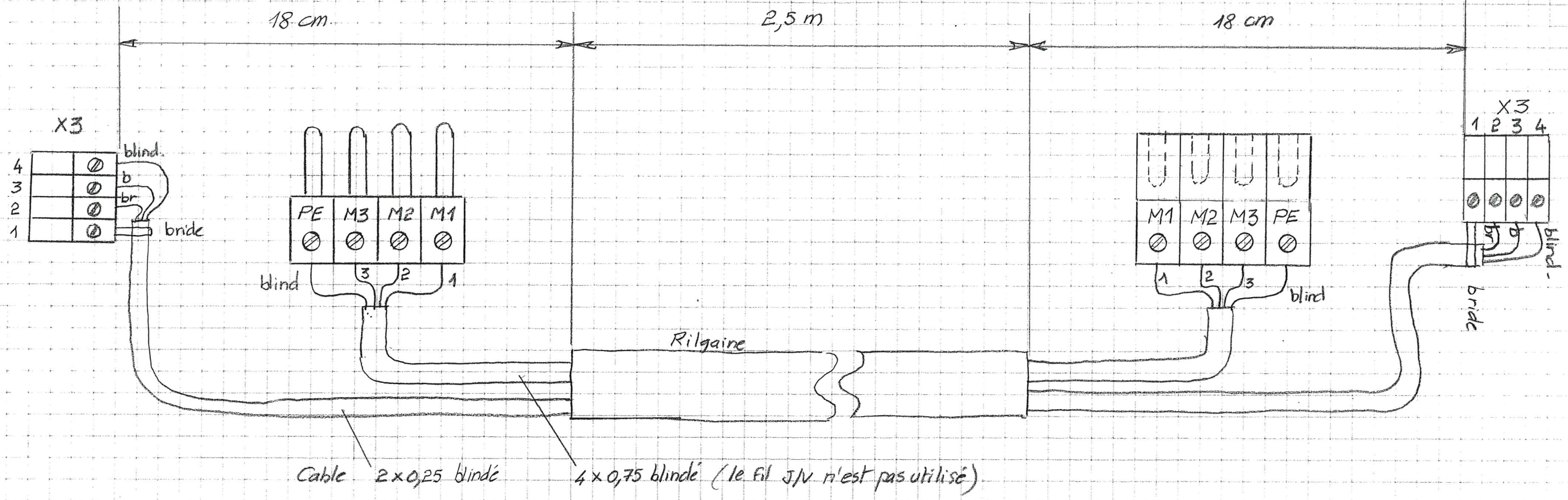

RPM ST1R0

Boîte de commutation

R	Observations :	Appareil No:	A3	
C	Modifications:	Sheet No:		
L	Cable MRO	Ech.	Dessine	Tartarat
D			Date	21/05/03
Q	Liaison ST1R0 → boîte de commutation COMMUTATION ROTATEUR P7.C3	Page	Etude	
.		/	Revise	
.	OBSERVATOIRE DE GENEVE			
.	Tel. (022) 755 26 11 / Fax. (022) 755 39 83			

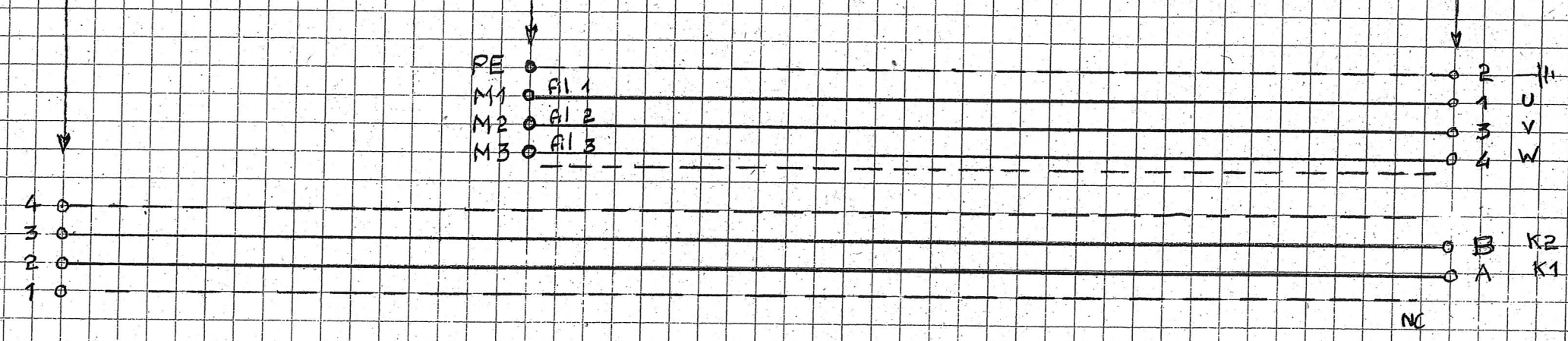
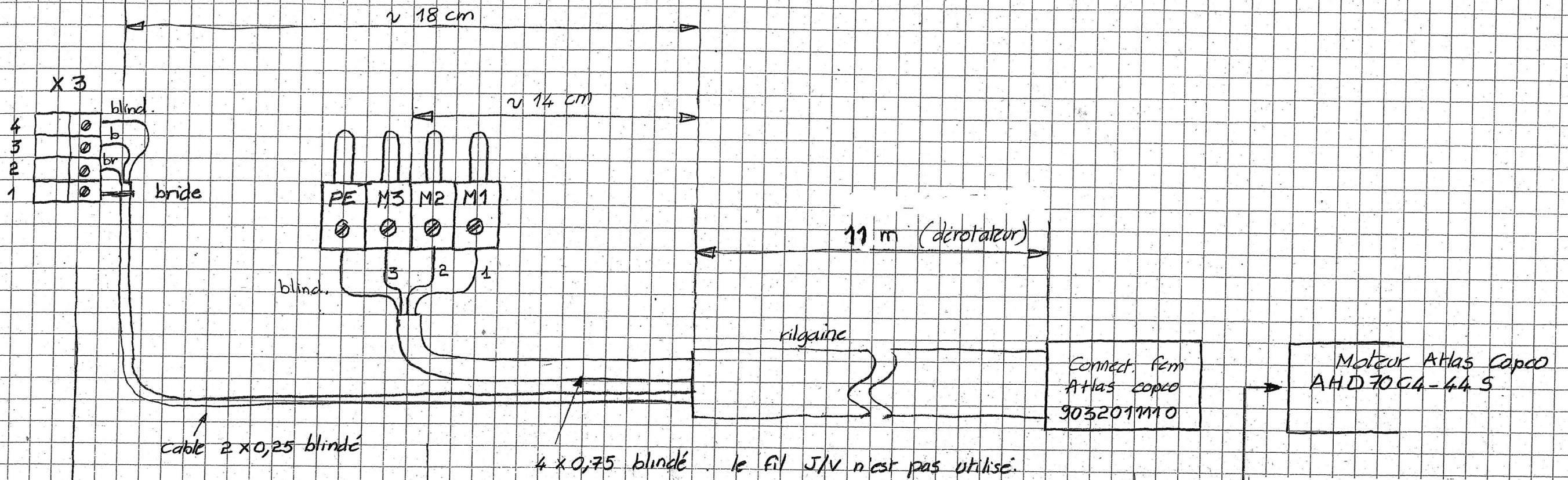

SUPPLY CONNECTOR

PIN	FUNCTION
1	MOTOR U
2	EARTH
3	MOTOR V
4	MOTOR W
A	THERMAL SENSOR K1
B	THERMAL SENSOR K2
C	BRAKE B+ (IF FITTED)
D	BRAKE B- (IF FITTED)

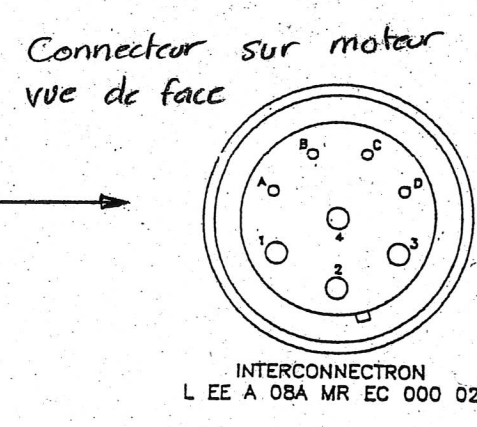

R	Observations :	Appareil No:	A3
C	Modifications:	Sheet No:	
L	boite commutation → Mot. Derot. P7	Ech.	Dessine Tartarot
D	CABLE MOTEUR MRO P7	Date	1/11/2001
G	DEROTATEUR P7	Page	Etude
		/	Revise
OBSERVATOIRE DE GENEVE			
Tel. (022) 755 26 11 / Fax. (022) 755 39 83			

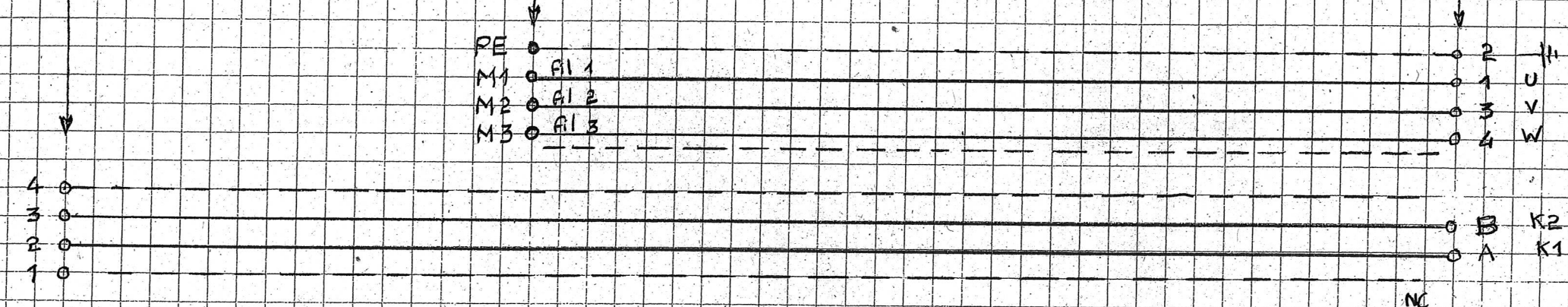
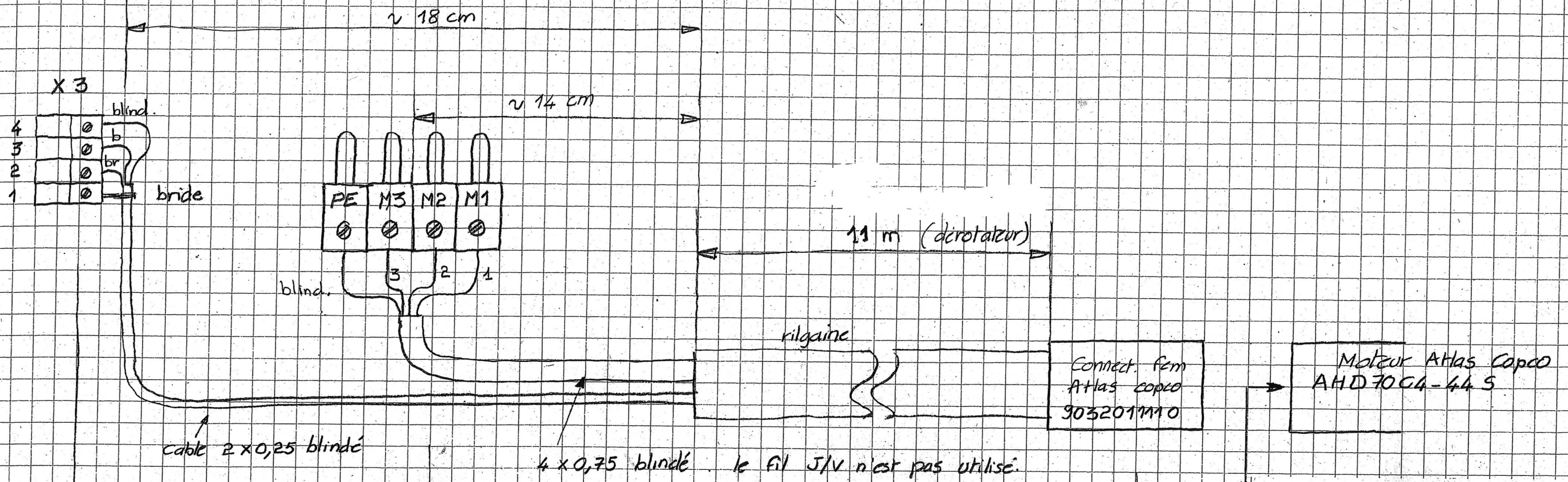

SUPPLY CONNECTOR

PIN	FUNCTION
1	MOTOR U
2	EARTH
3	MOTOR V
4	MOTOR W
A	THERMAL SENSOR K1
B	THERMAL SENSOR K2
C	BRAKE B+ (IF FITTED)
D	BRAKE B- (IF FITTED)

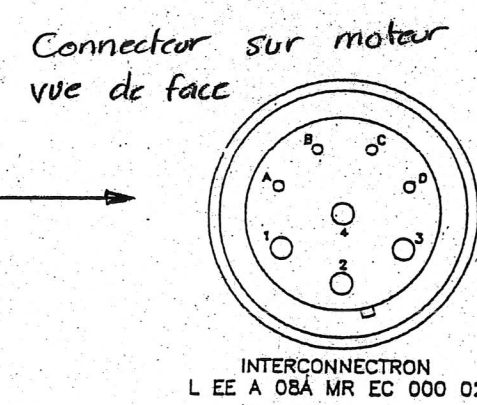

R	Observations :	Appareil N°:	A3
C	Modifications:	Sheet N°:	
L	Boite de commutation → Mot Derot C3	Ech. Dessine	Tartarot
D	CABLE MOTEUR MRDC3	Date	1/11/2001
Q	DEROTATEUR, C3	Page Etude	
		/ Revise	
OBSERVATOIRE DE GENEVE			
Tel. (022) 755 26 11 / Fax. (022) 755 39 83			

Boîtier ALUnorm 150 x 65 x 40

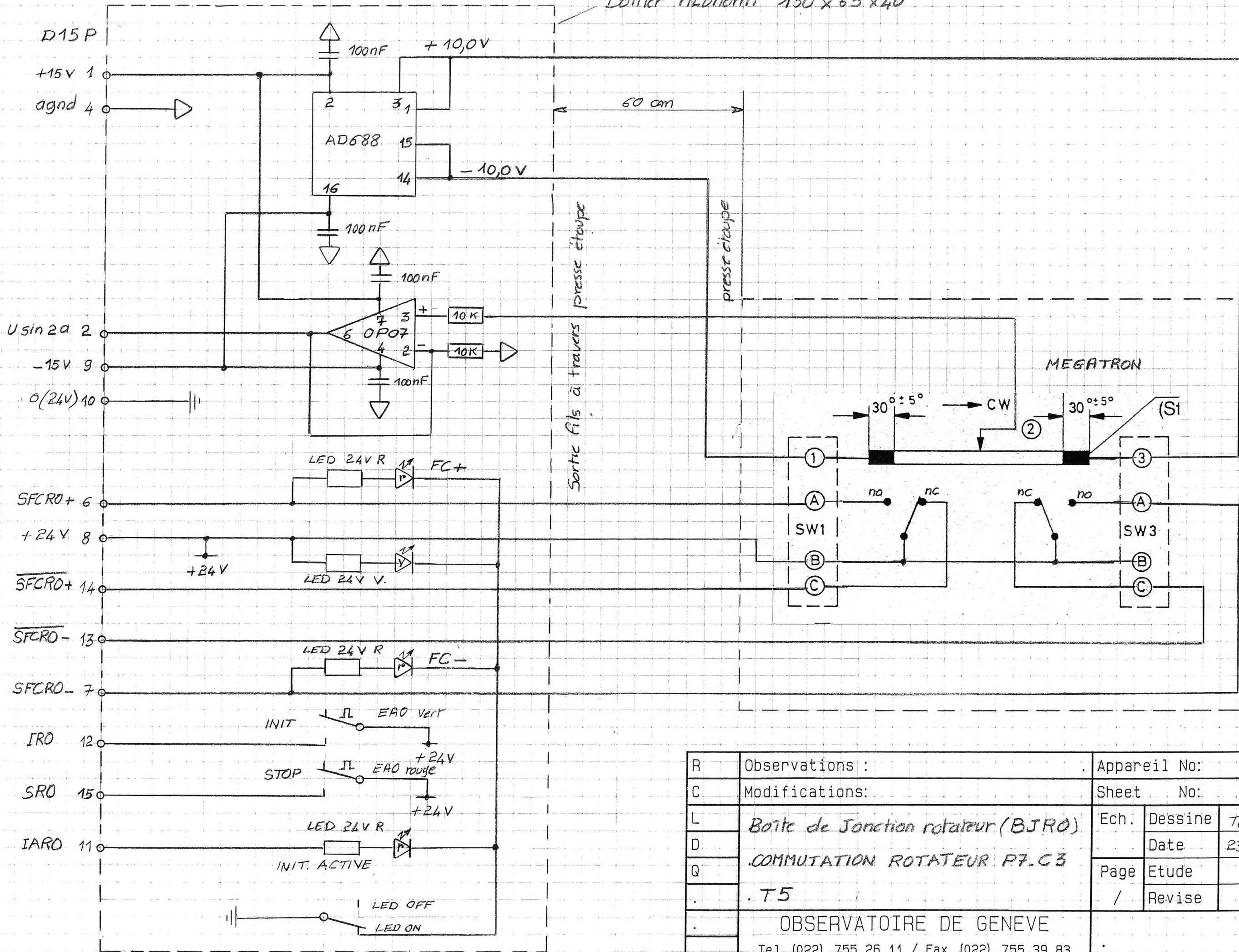

R	Observations :	Appareil No:	A3	
C	Modifications:	Sheet No:		
L	Boîte de Jonction rotateur (BJRO) COMMUTATION ROTATEUR P7.C3 T5	Ech.	Dessine	Tartarat
D			Date	23/04/2004
Q		Pàge	Etude	
		/	Revise	
OBSERVATOIRE DE GENEVE				
Tel. (022) 755 26 11 / Fax. (022) 755 39 83				

