

# AVT GigE (Bigeye/Pearleye/Goldeye)

---



## How to install a GigE camera

**Bigeye/Pearleye/Goldeye**

V2.1.0

04 May 2012

## **Legal notice**

### **Trademarks**

Microsoft, Windows, Windows 7, Windows Vista, and Windows XP are either registered trademarks or trademarks of Microsoft Corporation in the United States and/or other countries.

Unless stated otherwise, all trademarks appearing in this document of Allied Vision Technologies are brands protected by law.

### **Warranty**

The information provided by Allied Vision Technologies is supplied without any guarantees or warranty whatsoever, be it specific or implicit. Also excluded are all implicit warranties concerning the negotiability, the suitability for specific applications or the non-breaking of laws and patents. Even if we assume that the information supplied to us is accurate, errors and inaccuracy may still occur.

### **Copyright**

All texts, pictures and graphics are protected by copyright and other laws protecting intellectual property. It is not permitted to copy or modify them for trade use or transfer, nor may they be used on web sites.

### **Allied Vision Technologies GmbH 05/2012**

All rights reserved.

Managing Director: Mr. Frank Grube

Tax ID: DE 184383113

Headquarters:

Taschenweg 2A

D-07646 Stadtroda, Germany

Tel.: +49 (0)36428 6770

Fax: +49 (0)36428 677-28

e-mail: [info@alliedvisiontec.com](mailto:info@alliedvisiontec.com)

# Contents

<b>Contacting Allied Vision Technologies</b> .....	5
<b>Introduction</b> .....	6
Document history .....	6
Manual overview .....	6
Conventions used in this manual .....	7
Styles .....	7
Symbols .....	7
Before operation .....	8
Safety warnings .....	8
Cleaning instructions .....	9
<b>IP-based camera access: background</b> .....	10
<b>IP settings: preliminary considerations</b> .....	12
Obtain an IP address automatically (DHCP) .....	12
Link Local Address (LLA) .....	12
Static IP address .....	13
Static Persistent IP address .....	13
Static Persistent IP for GigE Vision camera .....	14
<b>General tips for setting IP addresses</b> .....	16
<b>Installing GigE driver from Pleora</b> .....	18
<b>Hardware connection and first power up</b> .....	19
LED states for different camera models .....	19
<b>Display camera live images</b> .....	20
Using AcquireControl .....	20
Select the grabber .....	20
Select the IP address .....	21
Select the camera .....	22
Select the image processing chain .....	23
Start the continuous snap .....	23
Advanced operations .....	24
Exposure control .....	24
Pseudo Color and Contrast Enhancement .....	28
Background Correction .....	29
Statistics and histogram .....	30
Using Pleora Coyote .....	31
Using Pleora GEVPlayer .....	33
Using Bigeye/Pearleye/Goldeye cameras with 3rd party solutions .....	33

---

Using National Instruments software .....	33
<b>Performance optimization</b> .....	36
Using AcquireControl .....	37
Using 3rd party solutions .....	37
<b>Adjusting firewall settings</b> .....	38
<b>Troubleshooting</b> .....	39
<b>Appendix</b> .....	41
GigE Vision register description .....	41
DeviceInformation .....	41
ImageSizeControl .....	42
AcquisitionControl .....	42
AnalogControls .....	43
CameraSpecialFeatures.....	44
CameraSpecialFeatures\TwoPointCorrection.....	46
CameraSpecialFeatures\BackgroundCorrection .....	46
CameraSpecialFeatures\LUT.....	47
CameraSpecialFeatures\IntegratorAndImageStore .....	47
CameraSpecialFeatures\BadPixelCorrection .....	47
GigE Vision timer calculations .....	48
Feature mapping .....	49
<b>Index</b> .....	50

# Contacting Allied Vision Technologies

## Info



- **Technical information:**  
<http://www.alliedvisiontec.com>
- **Support:**  
[support@alliedvisiontec.com](mailto:support@alliedvisiontec.com)

### **Allied Vision Technologies GmbH (Headquarters)**

Taschenweg 2a  
07646 Stadtroda, Germany  
Tel.: +49 36428-677-0  
Fax.: +49 36428-677-28  
e-mail: [info@alliedvisiontec.com](mailto:info@alliedvisiontec.com)

### **Allied Vision Technologies Canada Inc.**

101-3750 North Fraser Way  
Burnaby, BC, V5J 5E9, Canada  
Tel: +1 604-875-8855  
Fax: +1 604-875-8856  
e-mail: [info@alliedvisiontec.com](mailto:info@alliedvisiontec.com)

### **Allied Vision Technologies Inc.**

38 Washington Street  
Newburyport, MA 01950, USA  
Tel.: +1 978-225-2030  
Fax: +1 978-225-2029  
e-mail: [info@alliedvisiontec.com](mailto:info@alliedvisiontec.com)

### **Allied Vision Technologies Asia Pte. Ltd.**

82 Playfair Road  
#07-02 D'Lithium  
Singapore 368001  
Tel: +65 6634-9027  
Fax: +65 6634-902  
e-mail: [info@alliedvisiontec.com](mailto:info@alliedvisiontec.com)

# Introduction

This **Manual** describes in depth the installation of the AVT GigE cameras (Big-eye/Pearleye/Goldeye).

## Note

**Please read through this manual carefully.**



For more information, see

<http://www.alliedvisiontec.com/emea/support/downloads/product-literature.html>

## Document history

Version	Date	Description
V2.0.0	03.11.11	New Manual How to install a GigE camera (Bigeye/Pearleye/Goldeye)
V2.1.0	04.05.12	<ul style="list-style-type: none"> <li>• Reworked and updated all chapters.</li> <li>• Corrected screen shot in Chapter <a href="#">Start the continuous snap</a> on page 23</li> </ul>

Table 1: Document history

## Manual overview

This **manual overview** outlines the contents of each chapter of this manual.

- Chapter [Contacting Allied Vision Technologies](#) on page 5 lists AVT contact data (phone numbers and URLs) for both:
  - Technical information / ordering
  - Commercial information
- Chapter [Introduction](#) on page 6 (this chapter) gives you the document history, a manual overview (short description of each chapter) and conventions used in this manual (styles and symbols).
- Chapter [IP-based camera access: background](#) on page 10 gives you background information when working with IP-based cameras.
- Chapter [Installing GigE driver from Pleora](#) on page 18 gives you installing descriptions when working with the GigE driver from Pleora.
- Chapter [Hardware connection and first power up](#) on page 19 describes the hardware installation procedures.

- Chapter [Display camera live images](#) on page 20 describes in general how to get live images from IP-based cameras and display them.
- Chapter [Performance optimization](#) on page 36 describes how to optimize your system.
- Chapter [Adjusting firewall settings](#) on page 38 describes how to configure the firewall settings.
- Chapter [Troubleshooting](#) on page 39 helps you when you get in trouble.
- Chapter [Index](#) on page 50 gives you quick access to all relevant data in this manual.

## Conventions used in this manual

To give this manual an easily understood layout and to emphasize important information, the following typographical styles and symbols are used:

### Styles

Style	Function	Example
Bold	Programs, inputs or highlighting important things	<b>bold</b>
Courier	Code listings etc.	Input
Upper case	Register	REGISTER
Italics	Modes, fields	<i>Mode</i>
Parentheses and/or blue	Links	<a href="#">(Link)</a>

Table 2: Styles

### Symbols

**Note** This symbol highlights important information.



**Caution** This symbol highlights important instructions. You have to follow these instructions to avoid malfunctions.



**www**

This symbol highlights URLs for further information. The URL itself is shown in blue.



Example:

<http://www.alliedvisiontec.com>

## Before operation

We place the highest demands for quality on our cameras.

**Target group** This **Technical Manual** is the guide to detailed technical information of the camera and **is written for experts.**

**Note**

**Please read through this manual carefully before operating the camera.**



**Caution**

Before operating any AVT camera read the following **safety instructions** and **ESD warnings.**



## Safety warnings

**Caution**

**Electrostatic discharge**

The camera contains sensible electronic components which can be destroyed by means of electrostatic discharge.

Use sufficient grounding to minimize the risk of damage.





## Cleaning instructions

### Note



Dark spots on the image, especially at nearly closed aperture, are mostly caused by dust on the sensor of the camera.

Allied Vision Technologies GmbH cleans the sensors around the lens mount thread with pure air in a clean room class 1000.

After a careful test in the clean room a seal is affixed on the lens mount aperture.

To receive a dust-free overall system the opening of the seal and the fitting of the optic should also be done in a dust-free environment (clean room class better than 1000).

Therefore also a dust-free optic is necessary or rather the optic has to be cleaned with pure air first.

If, despite of all precaution, dust is on the sensor, the sensor-area should be blown out with pure air. Therefore compressed air aerosols are suitable (dust-off-sprays), e.g. *Druckluft 76* from CRC Industries, D-76473 Iffezheim, Tel.: 0049-7229-3030.

When using the air-sprays pay attention that the sprays are not moved or shaken. Otherwise it comes to an emission of fluid (propellant).

### Caution



Do not touch the sensor with tough objects. The glass is often scratched and the sensor gets damaged.

# IP-based camera access: background

In order to access a camera (or any other device) in the network, it is necessary that the camera and also the Network Interface Card (NIC) have a valid IP address. Every device in the network must have a unique IP address.

The following graphic illustrates the assembling of such network:

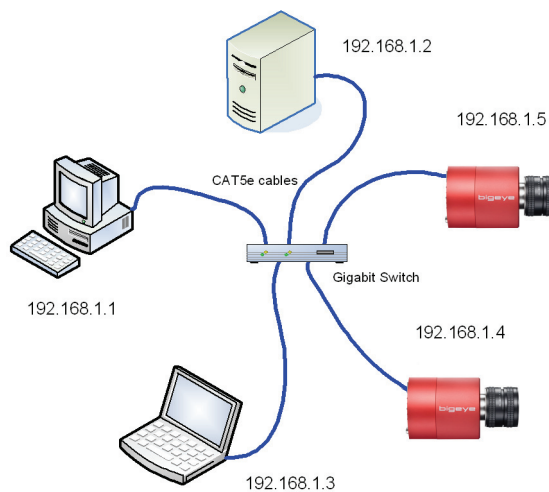

Figure 1: Network with IP-based cameras

The chosen IP addresses and the way the devices are connected in the illustration above are just an example. It is also possible to connect the camera directly to a PC/notebook.

The following subchapters describe which IP addresses can be used and how they are obtained.

In order to work properly with an AVT GigE camera consider the following:

**Note**



- AVT recommends to realize machine vision applications on **standalone computers only**. So you avoid interference with non-vision applications.
- Mixed uses may be possible, but this adds complexity, requires involving your corporate IT team, and may yield sub-optimal results.
- Firewalls may block the communication with the camera. In these cases ask your local IT department to disable the firewall for one NIC. Similar issues may happen with antivirus solutions.

- The NIC (Network Interface Card) of the PC must be Gigabit Ethernet (1000Base-T) compatible.
- To maximize hardware performance, devices that offer jumbo packet support (8 kB MTU size) are recommended.
- For best performance all network devices including cameras, PCs and switches should support the packet size output by the camera.
- If using Windows XP make sure that the Microsoft Hotfix KB926255 is installed.
- After the first functional test of the camera you can try to re-enable Firewalls and antivirus solutions step by step: see Chapter [Adjusting firewall settings](#) on page 38.
- If your PC/notebook has more than one network port, it is recommended to use one port for normal LAN traffic and the second port only for camera traffic.

## IP settings: preliminary considerations

There are several different ways the camera may get its IP address. Please refer to the following subchapters to choose the best solution for your application. Please also refer to Chapter [General tips for setting IP addresses](#) on page 16 for additional information how to set an IP address for a NIC (Network Interface Card).

### Obtain an IP address automatically (DHCP)

The Dynamic Host Configuration Protocol is used to set the IP address of a network device (the camera) dynamically by an external DHCP server. If your LAN already uses a DHCP server you only have to connect the camera to the LAN and the IP configuration is done automatically. Please contact your local network administrator regarding DHCP.

Example:	PC	192.168.101.21	↔ Set by the DHCP server automatically after every PC power up.
	Camera	192.168.101.198	↔ Set by the DHCP server automatically after every camera power up.

### Link Local Address (LLA)

The Link Local Address scheme (Zero Configuration Networking or Automatic Private IP Addressing) is the easiest way to set the IP address. The IP address of the camera is automatically set without any external server. In order to use this method the IP address of the NIC just has to be obtained automatically (see Chapter [Obtain an IP address automatically \(DHCP\)](#) on page 12)

Example:	PC	169.254.1.1	↔ Set automatically after PC power up.
	Camera	169.254.1.152	↔ Set automatically after every camera power up to a random number within the subnet.

## Static IP address

The camera can also use a static IP address. This address can be set while connecting to the camera with **AVT AcquireControl** software.

**Note** The Pleora driver has to be installed to run this application.

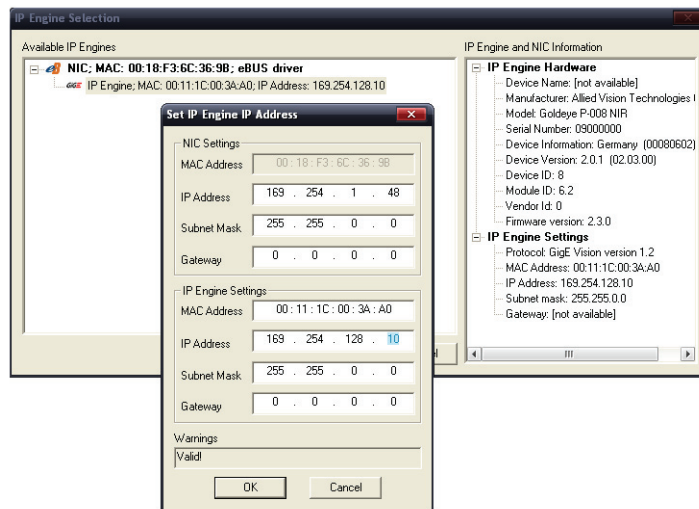

Figure 2: Select static IP address

Example:	PC	192.168.1.1	↔ Set by the user once
	Camera	192.168.1.2	↔ Set by the user manually after every camera power up.

## Static Persistent IP address

Here the camera gets a static IP address which is stored persistently in the camera. So after every power up of the camera the same IP address is available.

Example:	PC	192.168.1.1	↔ Set by the user once
	Camera	192.168.1.2	↔ Set by the user once

## Static Persistent IP for GigE Vision camera

To store a persistent IP for a camera with GEV firmware, use the Pleora software GEVPlayer. Please refer to Chapter [Installing GigE driver from Pleora](#) on page 18.

1. Open GEVPlayer, select the camera and set the desired persistent IP

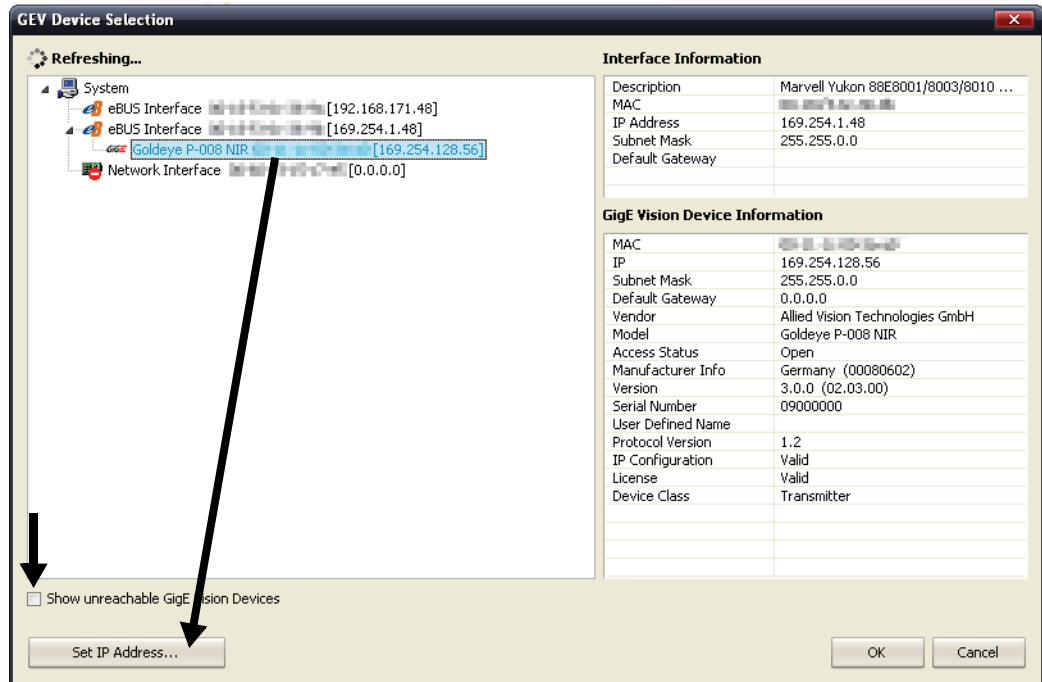

Figure 3: GEV Device Selection

2. Open the **GEV Device Control** dialog and change the following values:

GevCurrentIPConfigurationPersistentIP

⇒ Set to true

GevPersistentIPAddress

⇒ Set IP Address

GevPersistentSubnetMask

⇒ Set Subnet Mask

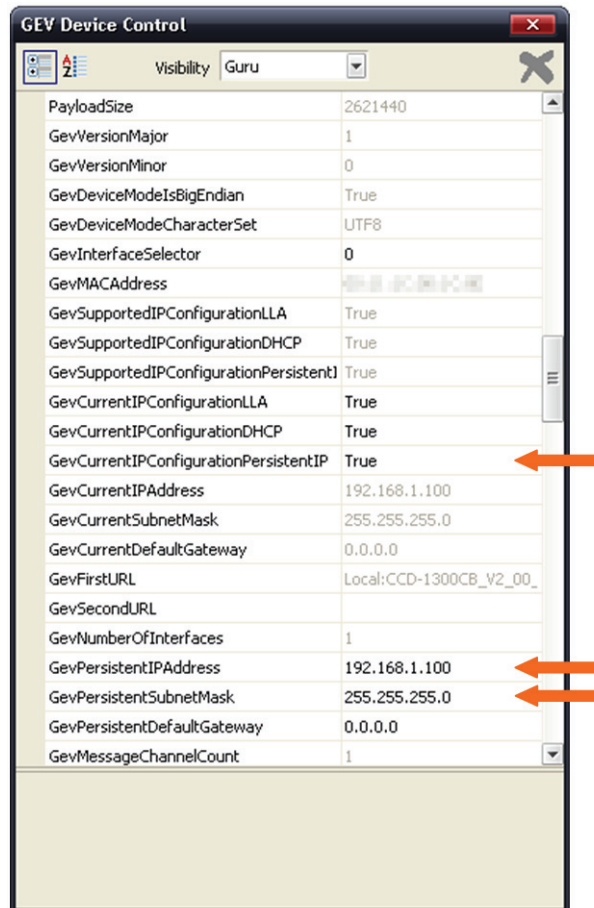

Figure 4: GEV Device Control

# General tips for setting IP addresses

1. While changing Windows IP address settings make sure that no camera application is running.
2. To set the IP address of a PC NIC, open the network connections (Start -> Settings -> Network connections). Then open the properties window of the desired connection.

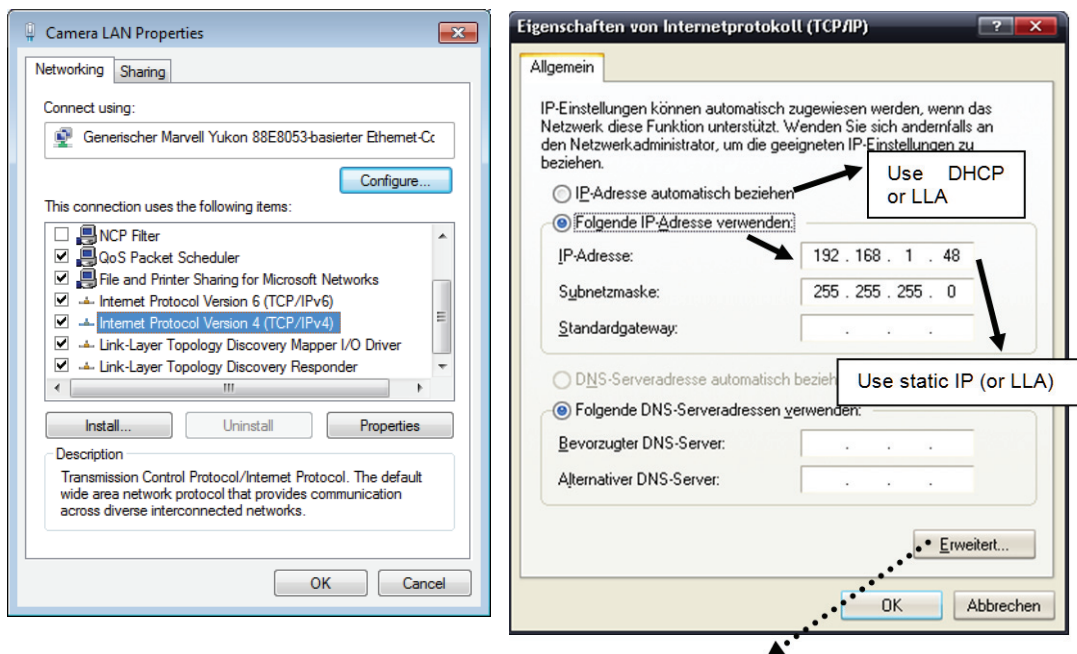

Figure 5: Set IP address



- It is also possible to add a second (or even more) IP address(es) to the NIC. In this case the Pleora IP engine always uses the bottom entry of the IP list:

Example: This NIC works with two IP ranges:

- Static IP address for LAN traffic
- LLA for a camera

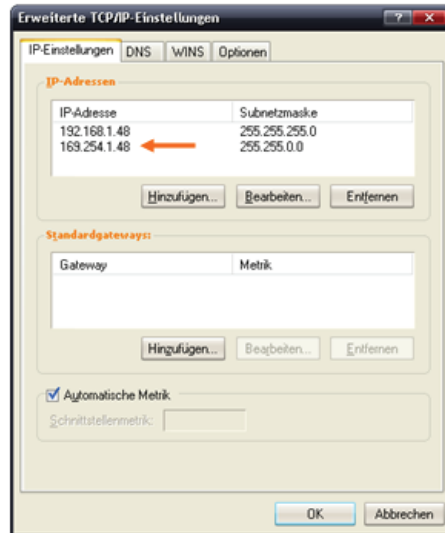

Figure 6: Pleora IP engine uses the bottom entry of the IP list

To verify which NIC IP address is used by the Pleora IP engine, click on the NIC entry during camera selection process.

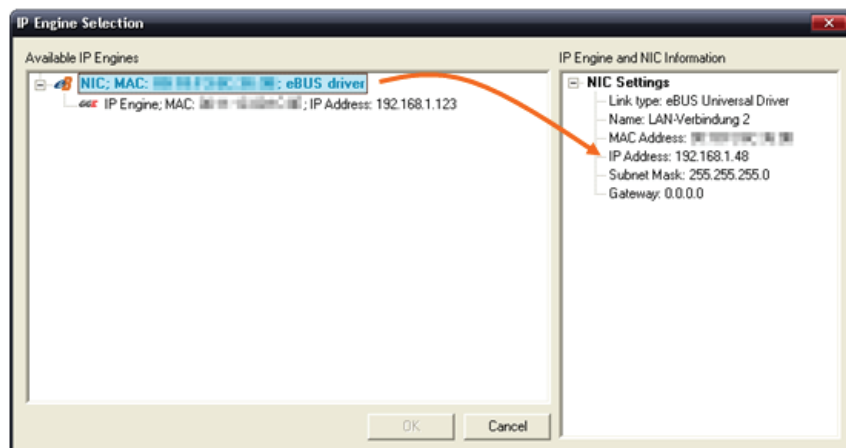

Figure 7: IP Engine Selection

---

# Installing GigE driver from Pleora

In order to access a camera it is not necessary to install a driver.

**Note**



We recommend to use the iPORT/eBUS filter driver architecture for the best performance. (NIC manufacturers drivers usually have a slow performance.)

It is not necessary to install any driver if you want to work with National Instruments applications.

3rd party solutions also support GEV compliant cameras.

Before you install a driver make sure that all old Pleora drivers have been deinstalled. After deinstallation restart the computer.

# Hardware connection and first power up

1. Connect the camera via a CAT5e cable to the PC/notebook. This can be done directly or over a gigabit network switch.
2. Connect the camera to the power supply.
3. Power on the camera and verify the state of the LEDs on the backside of the camera. It can take up to 5 seconds until the camera is ready for use.



Figure 8: LED states

## LED states for different camera models

Bigeye cameras	Goldeye Cameras	Pearleye cameras
L2: Constantly ON	L2: Constantly ON	L2: Constantly ON
L3: OFF (IOD or temperature state for COOL cameras)	L3: OFF (Cooling state, OFF = OK)	L3: OFF (Cooling state OFF = OK)
Power: Constantly ON	Power: Constantly ON	Power: Constantly ON
L4: OFF (Exposure input)	L4: OFF (Exposure input)	L4: No function
L5: ON (for every frame)	L5: ON (for every frame)	L5: No function

Figure 9: LED states

# Display camera live images

You can use various software applications to display live camera images.

The following subchapters describe how to get a live image with:

- AcquireControl
- Pleora Coyote
- Pleora GEVPlayer
- 3rd party solutions

Refer to the technical documentation of these software solutions.

## Using AcquireControl

Most of the following settings are stored by the application, so these configuration steps are necessary only once.

### Select the grabber

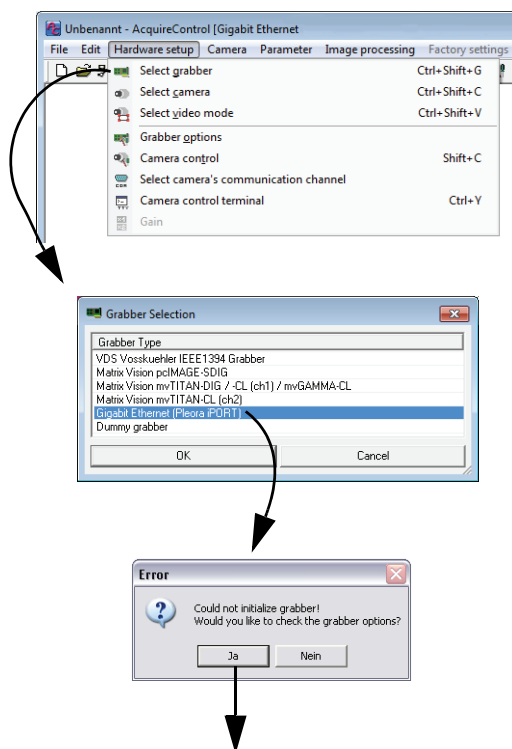

Figure 10: Select grabber

The IP Engine Selection dialog appears.

## Select the IP address

In dependence of the driver version you use, the appearance of this dialog may differ. If an IP address could not be set automatically it can be set within this dialog manually.

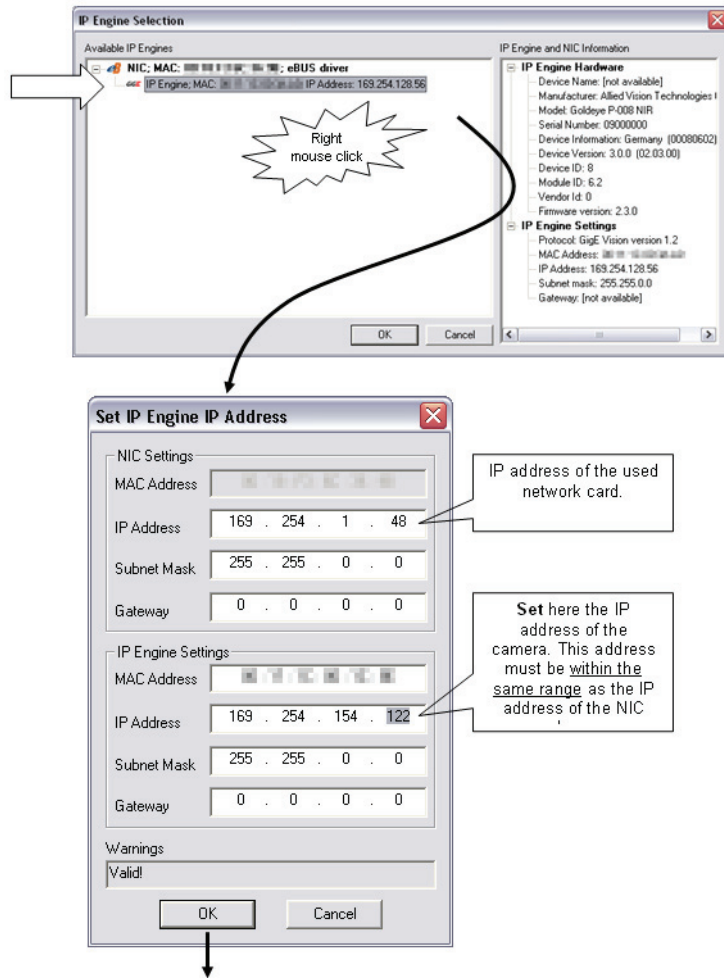

Figure 11: Select IP address

After closing the **Set IP Engine IP Address** dialog you now can select the eBUS Filter driver entry.

## Select the camera

**Bigeye cameras**
**Goldeye cameras**
**Pearleye cameras**

Model	Description	M
Bigeye P-1100B Cool		4
Bigeye P-1100C Cool		4
Bigeye P-131B		4
Bigeye P-131B Solar Cool		4
Bigeye P-629B Cool		2
Bigeye P-629B Solar Cool		2
Bigeye P131B Cool		4
Bigeye P131C Cool		5
CCD-1000X		4
CCD-1000XR		2
CCD-1003		4
CCD-1020		4
CCD-11000		4
CCD-11000C		4
CCD-11000D		4
CCD-11000L		4
CCD-11000LC		4
CCD-11000LGE		6
CCD-11000XRCLXRGE		4
CCD-1100X		4
CCD-1300		2
CCD-1300B		4
CCD-1300BG		4
CCD-1300BSI		4
CCD-1300CB		5
CCD-1300CDS		4
CCD-1300CF		5
CCD-1300D		4
CCD-1300DS		4
CCD-1300F		4
CCD-1300FSI		4

Model	Description	M
CCDL-1300DS		4
CCDL-1300I		4
CCDL-1300QCL		5
CCDL-1300QCL CL/GE	CameraLink, GigE	5
CCDL-1300QL		4
CCDL-1300QL CL/GE	CameraLink, GigE	4
CCDL-1300QM		4
CCDL-1300QSGE		4
CCDL-4300	SDIG	4
CCDL-4300CL/GE		3
CCDL-6000		4
CCDL-6000GE		2
Goldeye CL-008 NIR		2
Goldeye CL-008 NIR Cool		2
Goldeye CL-032 NIR		1
Goldeye CL-032 NIR F-Mount		1
Goldeye P-008 NIR		2
Goldeye P-008 NIR Cool		2
Goldeye P-032 NIR		1
Goldeye P-032 NIR F-Mount		1
HCC-1000 (1024 MB)		3
HCC-1000 (512MB)		3
HCC-1000 S150 (512 MB)		3
HCC-1000 S400 (1024 MB)		3
HCC-1000 S400 (512 MB)		3
HCC-1000B (1024 MB)		3
HCC-1000B (512MB)		3
HCC-1000B S400 (1024 MB)		3
HCC-1000B S400 (512 MB)		3
HCC-1000F (512 MB)		3
HCC-1000FB (512 MB)		3

Model	Description	M
HCC-1000 (1024 MB)		3
HCC-1000 (512MB)		3
HCC-1000 S150 (512 MB)		3
HCC-1000 S400 (1024 MB)		3
HCC-1000 S400 (512 MB)		3
HCC-1000B (1024 MB)		3
HCC-1000B (512MB)		3
HCC-1000B S400 (1024 MB)		3
HCC-1000B S400 (512 MB)		3
HCC-1000F (512 MB)		3
HCC-1000FB (512 MB)		3
HCC-1200C (1280 MB)		3
IRC-300 Series	SDIG	2
IRC-300CL/GE Series		1
IRC-300IE		1
IRC-300IER		1
IRC-340GE		1
IRC-600CL/GE		1
NIR-300	SDIG, IEEE-1394	2
NIR-300(P)CL/GE	CameraLink, GigE	1
NIR-300F	SDIG, IEEE-1394	2
NIR-300F(P)CL/GE	CameraLink, GigE	2
NIR-300P	SDIG, IEEE-1394	2
NIR-300PF	SDIG, IEEE-1394	2
NIR-600PCL/GE	CameraLink, GigE	1
Pearleye P-007 LWIR		1
Pearleye P-007 LWIR High Temp		1
Pearleye P-030 LWIR		1
X-Ray P-1100 Detector		4
X-Ray P-1100 Detector Cool		4

Table 3: Select the camera model you want to use

## Select the image processing chain



Figure 12: Select image processing chain

## Start the continuous snap



Figure 13: AcquireControl: Start continuous snap

You get live images from the camera with the default exposure time and default camera settings. You can stop the live image by **Stop snap**.

## Advanced operations

The AcquireControl software was developed for many different cameras. This chapter introduces the basic commands for controlling your camera.

### Exposure control

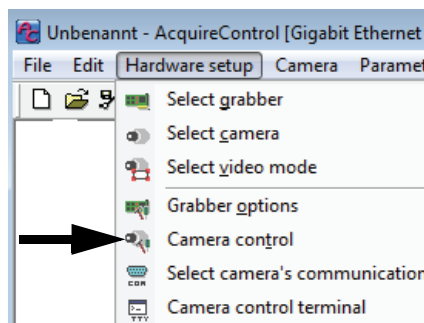

Figure 14: Camera control

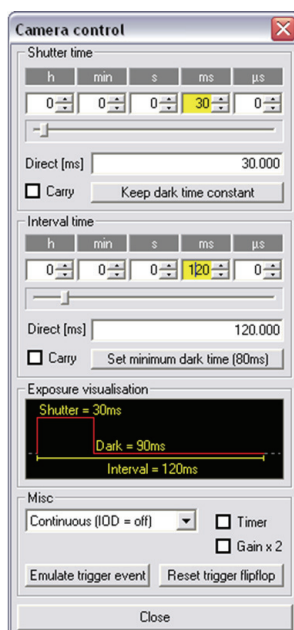

Figure 15: Camera control: Exposure control



### Bigeye cameras

Mode	Screenshot
Continuous Mode. The camera uses its built-in exposure signal, which is always constant.	
IOD Timer Mode. The exposure signal is generated by a timer, which can be adjusted with the dialog.	
IOD Trigger Mode. The camera waits for an external exposure signal.	

Table 4: Exposure control: continuous mode and IOD modes

### Goldeye cameras

NIR cameras have an internal non-uniformity correction and bad pixel correction. The non-uniformity depends on the exposure time and the gain, so you have to change the correction in case of changing the exposure time or gain.

To get a good image quality, we have prepared and stored different correction sets inside the camera. So it is very easy to change the correction when changing the exposure time or gain.

To adjust the exposure time, you always have to process two steps:

1. Adjust the Exposure time or Continuous mode and Gain setting like described in Chapter [Bigeye cameras](#) on page 25.
2. Select the corresponding correction data set as follows:

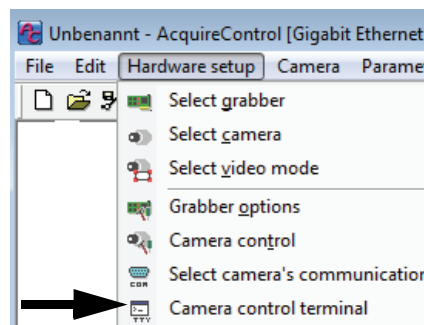

Figure 16: Camera Control Terminal

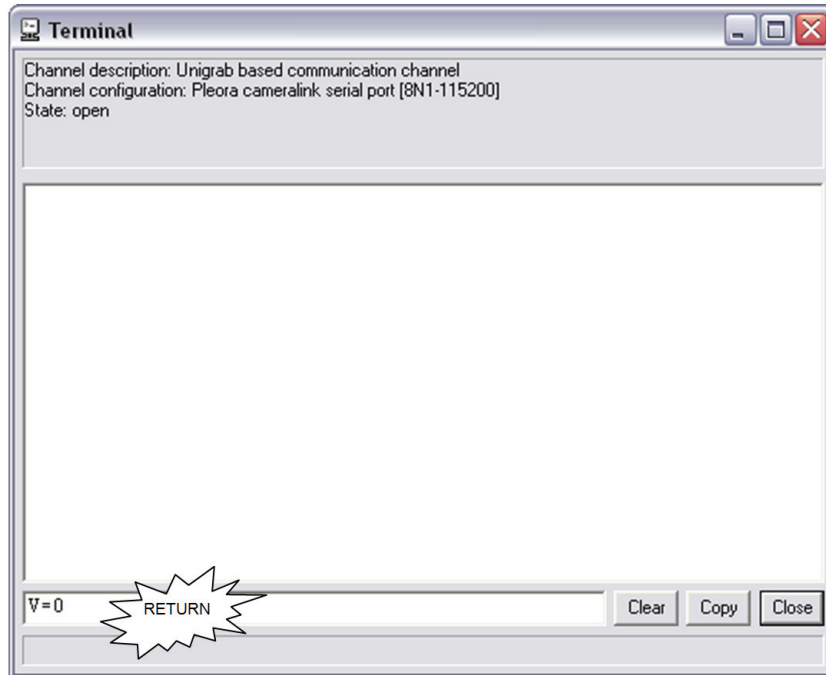

Figure 17: Goldeye: Terminal example: V=0

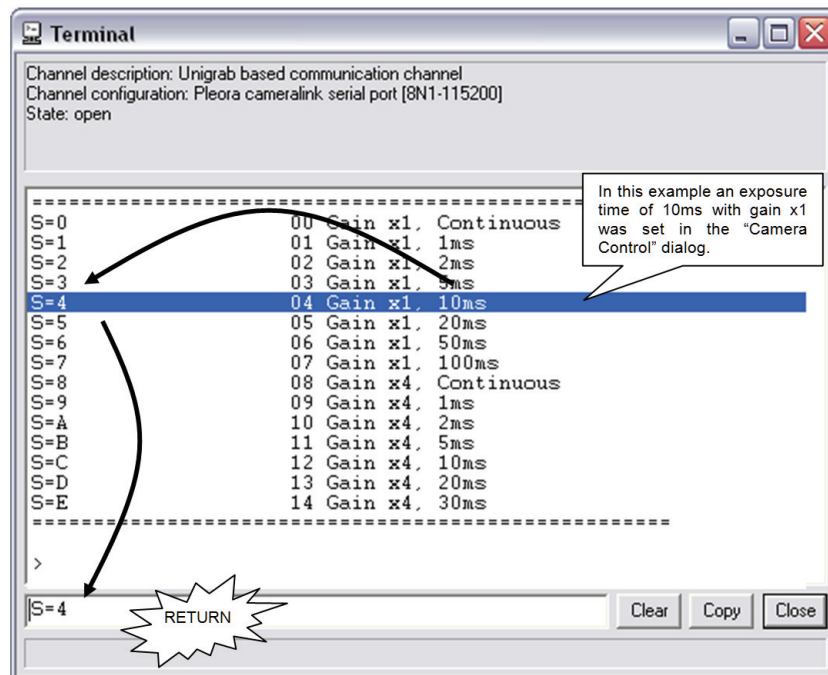

Figure 18: Goldeye: Terminal example: S=4

**Note** \_\_\_\_\_ V and S are upper case letters



**Pearleye cameras**

For Pearleye cameras it is not possible the change the exposure time.

Due to the microbolometer sensors, Pearleye cameras always work in Continuous mode.

After the camera warm-up phase and during operation: Calibrate the internal image correction.

**Note** \_\_\_\_\_ For detailed information, see **Pearleye Technical Manual**.

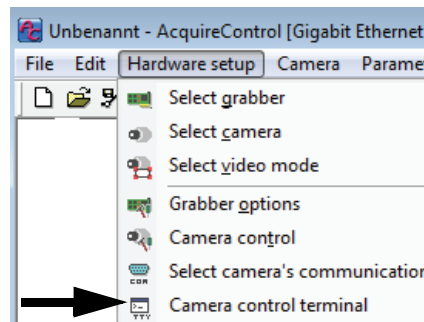

Figure 19: Camera Control Terminal

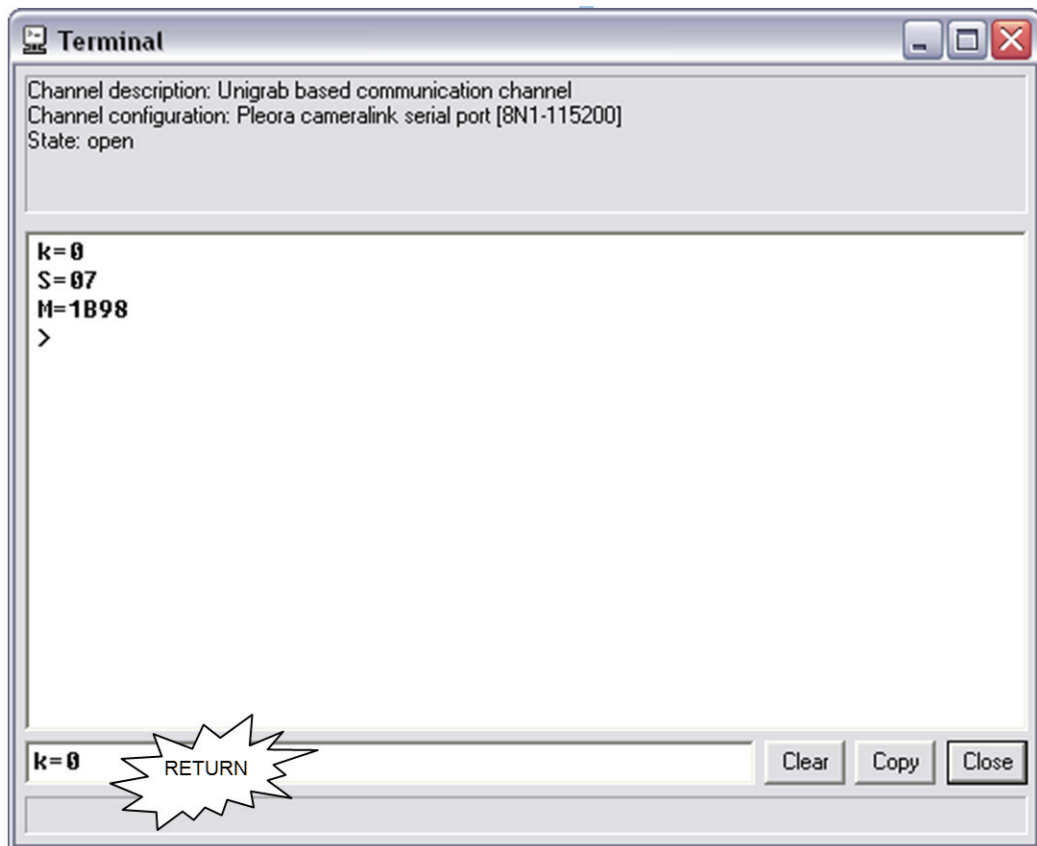

Figure 20: Pearleye: calibration

The calibration can be started by the command `k=0`. After some seconds the camera is calibrated.

**Note** \_\_\_\_\_ `k` is a lower case letter



## **Pseudo Color and Contrast Enhancement**

With the help of the **Pseudo color** dialog you can change the display of an image. Also you have the possibility to change the contrast of the displayed image to see more details of the 12-bit values.

**Note** Don't adjust this with the camera parameters. The contrast slider only changes the displayed values of the 12-bit camera image and not the camera data itself.



**Note** The availability of this dialog depends on the chosen image process chain (see Chapter [Select the image processing chain](#) on page 23).

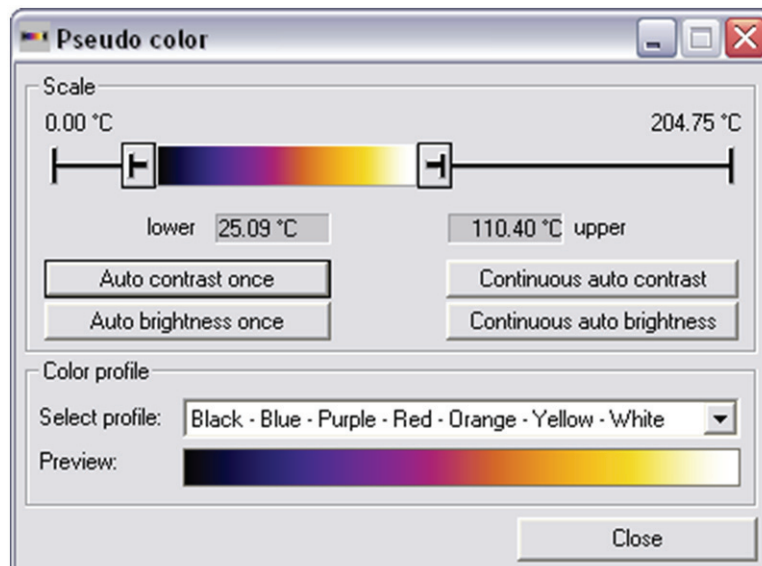

Figure 21: Pearleye: Pseudo color

## Background Correction

You can add an additional background correction (see **Image processing** menu) in the AcquireControl to get an improved image quality.

Therefore the following three steps are necessary:

- Record a homogenous image.
- Set the average value of the image as offset value for the correction.
- Apply (switch on) the correction.

**Note** The availability of this dialog depends on the chosen image process chain (see Chapter [Select the image processing chain](#) on page 23).



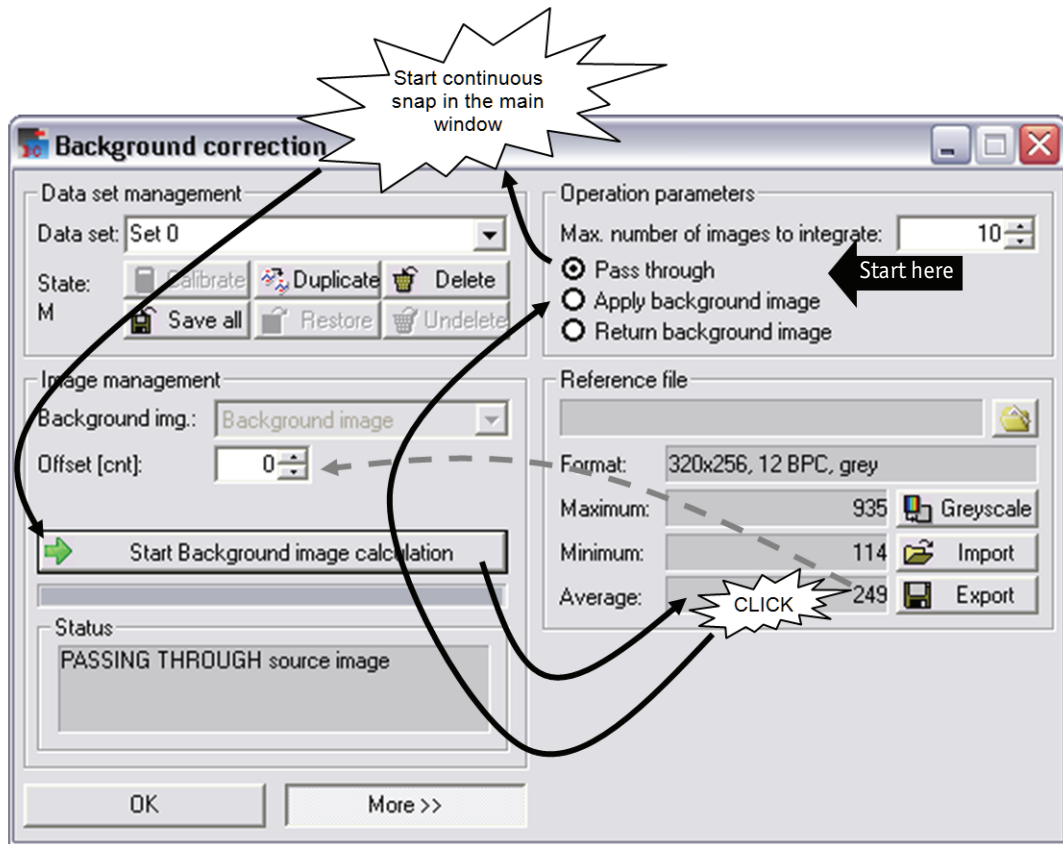

Figure 22: Pearleye: Background correction

### Statistics and histogram

It can be very useful to take a look at the statistic / histogram values to be sure that the light conditions are OK (see **Image processing** menu).

For a good light condition of the scene, the histogram of the image is balanced to the middle of the 12 bit ( $4096/2=2048$ ), as shown below.

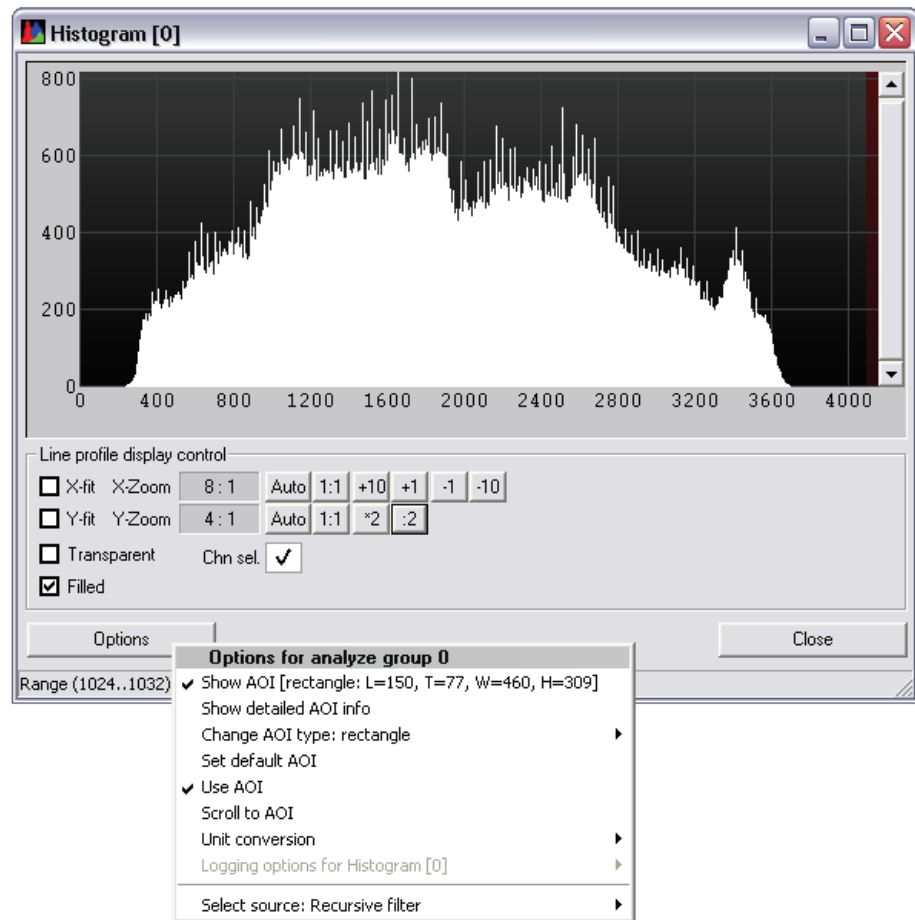

Figure 23: Pearleye: Statistics and histogram

Click **Options** to calculate the histogram for the entire image or only for an AOI.

## Using Pleora Coyote

1. Install the **GigE VDS Camera Integration DLL**. Ask AVT Application Engineering (Technical support) for details.
2. Start Coyote.
3. Select the camera by Click **Detect...** to select the camera and set IP (if necessary).
4. Select the camera type.
5. Click **Connect**.
6. Go to the **Acquisition** tab and click **Start**.

If the **GigE VDS Camera Integration DLL** is not installed, the Programmable Logic Controller of the IP Engine and the image format has to be setup manually:

7. After connecting to the camera click **Configure**.
8. Adjust the settings for IO ... I7 and the Lookup Table as follows:

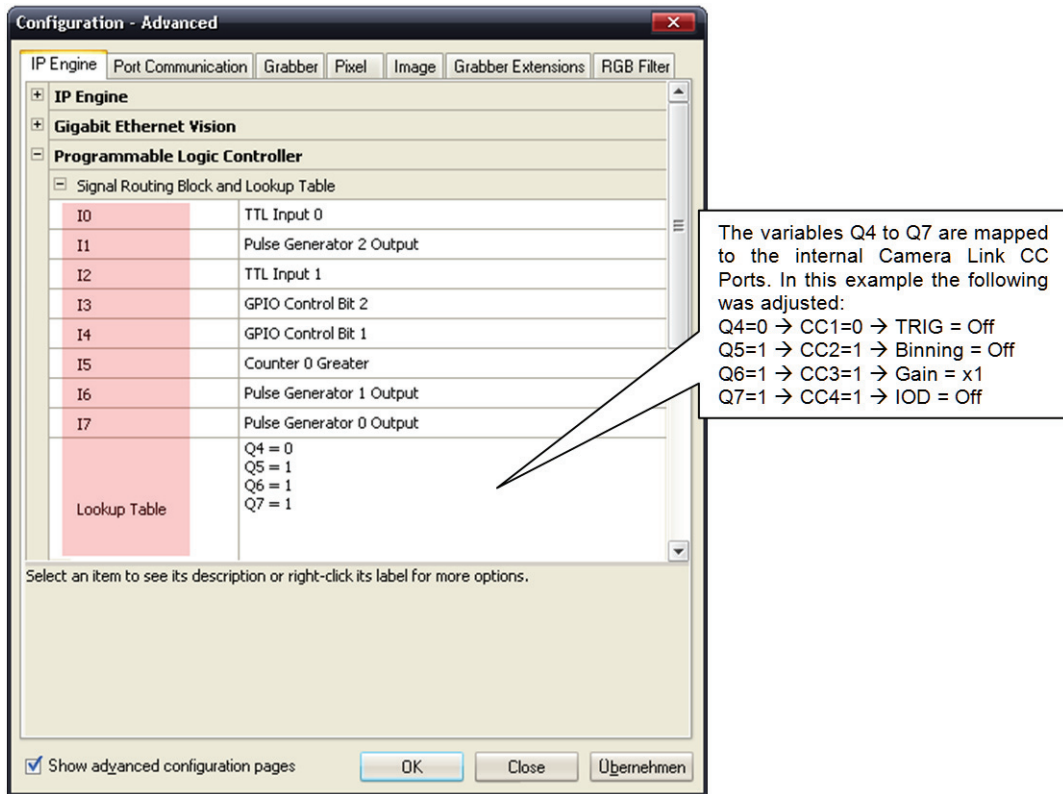

Figure 24: Pleora Coyote: Configuration

9. Click **Pixel** tab and select the correct **Color space** and **Pixel depth**.
10. Click **Image** tab and adjust the image size corresponding to the used camera.



## Using Pleora GEVPlayer

The Pleora GEVPlayer is an application which can grab images from a camera with GigE Vision compliance. All Bigeye/Pearleye/Goldeye cameras are GigE Vision V1.2 compliant.

**Note** In order to work with a GigE Vision compatible camera it is necessary to use at least Pleora driver version 2.3.3.



1. Start GEVPlayer.
2. Click **Select / Connect** to select the camera and set IP (if necessary).
3. Click **Play**.
4. If you want to switch between a GigE Vision application (e.g. GEVPlayer) and an iPORT application (e.g. AcquireControl), it is necessary to power cycle the camera.

## Using Bigeye/Pearleye/Goldeye cameras with 3rd party solutions

### Using National Instruments software

In order to work with LabView or compatible applications, it is necessary to have the NI IMAQdx driver installed. Without this driver it is not possible to access a GigE Vision camera!

To test the camera, start the MAX (Measurement & Automation Explorer) software.

1. Whether the IMAQdx driver is installed correctly can be verified in the **Software** branch:

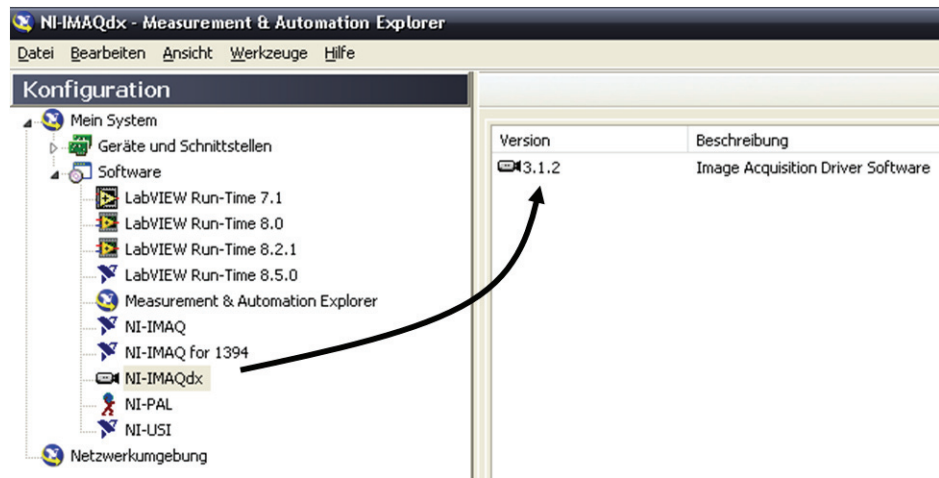

Figure 25: IMAQdx driver

2. Open the **Devices and Interfaces** branch. After a few seconds the camera should appear.
3. Click once on the camera entry. Now every register of the camera is read which can take a few seconds.
4. In the lower pane of the MAX software now several controls appear for accessing the camera parameters. Please also refer to Chapter [Appendix](#) on page 41 for more information regarding the registers.

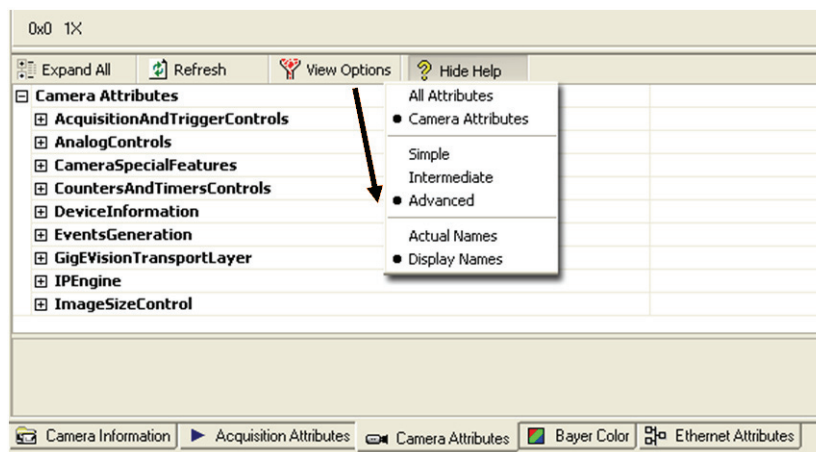

Figure 26: MAX: CameraAttributes

5. Click **Grab** to start continuous grab.
  - In some situations the software can't access the camera correctly anymore. Here it may help to reset the device cache of the NI software. Quit

all NI applications and delete all files and folders within the following directory:

C:\Documents and Settings\All Users\Documents\National Instruments\NI-IMAQdx\Data

- When you want to switch between a GigE Vision application (e.g. NI MAX) and an iPORT application (e.g. Coyote), it is necessary to power cycle the camera.
- In some situations the MAX software is not able to confirm the used pixel format. In this case open the **Acquisition Attributes** tab and reselect the desired **Pixel Format**.
- The default setting for the packet size of the NI MAX software is 8000 bytes. If your network card can't handle packets of this size, check the Jumbo Frames settings of your network adaptor (see Chapter [Performance optimization](#) on page 36) or reduce the packet size in NI MAX (⇒ Acquisition Attributes ⇒ Packet Size).

## Performance optimization

The video data from the camera is (like all other data in the network) transferred in packets. The default value for this packet size is 1440 bytes. In some cases it can be an advantage to increase this packet size because then fewer packets are needed to transfer the image data. This results in less overhead and better performance. But these oversized packets are not standardized so not every network card / device supports it. To determine if your network card supports it follow these steps:

1. Open the device manager
2. Open the properties of the network card. Try to find a value called **Jumbo Frames**, **Jumbo Packets** or **Packet Size** and change it to the maximum, e.g. 9014 Bytes.

If the camera is not connected directly to the PC but over a switched network, it is important to know that also the switches must support jumbo frames.

The following illustration shows an example for a network with several switches. The maximum packet size between the PC and the camera in this example is 4088 bytes.

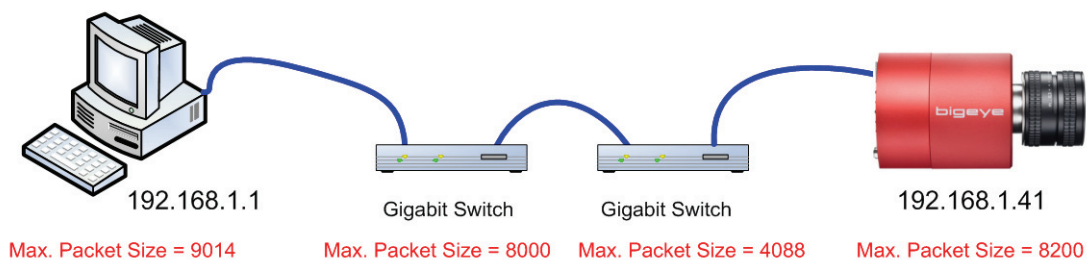

Figure 27: Performance optimization with jumbo packets

Refer to the technical data of the switches to determine if Jumbo Frames are supported.

If you have determined the maximum size of a packet you can modify the used packet size in your application.

**Note** The maximum packet size the iPORT protocol can use is 8128 bytes.



---

## Using AcquireControl

1. Close AcquireControl.
2. Go to the installation directory.
3. Open the file UniGrab.ini with a text editor.
4. Find the **GRABBER\_** section with the description Gigabit Ethernet (iPORT)
5. Find the value PacketSize and enter the determined Jumbo Frame size – 72 bytes.
6. Save the file and start AcquireControl again.

## Using 3rd party solutions

### Using National Instruments software

1. Start MAX.
2. Open the camera.
3. In the lower pane open the **Acquisition Attributes** tab, find the **packet size** value and enter the determined Jumbo Frame size – 72 bytes.

# Adjusting firewall settings

1. For the first test all firewalls and antivirus solutions should be disabled. Only when the camera can be accessed properly without any firewall one can try to adjust firewall settings step by step.

The communication from and to the camera is done in the UDP protocol.

2. A global rule for incoming and outgoing traffic should be created

**Rule: Pleora outgoing (Allow)**

- Protocol: UDP
- Direction: Outgoing, Packet type: Local
- Remote Host: 255.255.255.255  
xxx.xxx.xxx.xxx ← IP range the camera is in,  
e.g. 169.254.\*.\*
- Remote Port: 4  
68  
3956  
20200  
20201  
20202

**Rule: Pleora incoming (Allow)**

- Protocol: UDP
- Direction: Incoming
- Remote Host: xxx.xxx.xxx.xxx ← IP range the camera is in,  
e.g. 169.254.\*.\*

# Troubleshooting

- If the camera can be detected but no images can be grabbed, verify the camera operation mode. Make sure the camera operate with Continuous Mode, and not with IOD mode. The three modes have the following meaning:
  - Continuous Mode – The camera generates the images with a constant exposure time independently. This exposure time cannot be adjusted.
  - Image On Demand (IOD) Trigger mode – The camera produces no image until an external trigger impulse reaches the trigger input pin of the camera.
  - Image On Demand (IOD) Timer mode – The trigger impulses are generated internally by a timer which can be adjusted in the software.

Sometimes the camera was adjusted to an IOD mode by mistake. Verify the following settings:

## AcquireControl

- Open the **Camera control** dialog
- Check if in the **Misc** group either Continuous (IOD = Off) with disabled **Timer** or **IOD = On** with enabled **Timer** was chosen.
- Remember that the settings within the **Shutter time** group and the **Interval time** group are only used when **IOD = On** with enabled **Timer** was chosen.

## Coyote

- Make sure that the **GigE VDS Camera Integration DLL** was installed.
- Open the **Configuration – Advanced** dialog and select the Camera Properties tab.
- Verify the settings of **Timer Mode**, **Image On Demand**, **Exposure Time ms** and **Dark Time ms**

## GEVPlayer & NI MAX

- Go to the **AcquisitionAndTriggerControls** branch
- Check state of **TriggerMode**
- Check state of **StartExposureTimer**
- Verify the values of **DarkTime** and **ExposureTime**. (Formerly DarkTimeAbs and ExposureTimeAbs).

- If the camera cannot be detected, verify all settings from the driver installation description. Make sure that no third party network filter driver (e.g. VPN driver) conflicts with the Pleora driver. Disable all Firewalls and Anti-virus solutions. Power cycle the camera.
- Restart the computer.
- Do you have Jumbo Packets enabled? Ensure that every network device supports the adjusted packet size. Try setting to the default packet size of 1440 bytes.

- Launch the **Information Gathering Tool** which was installed with the Pleora driver package. A shortcut to this program can be found in the **Pleora Technologies Inc** folder of the Start menu. Save the generated output to a file.
- Make screenshots of the problem and the network connection dialogs of windows.
- Write down the state of the LEDs on the backside of the GIP-1000 camera module.
- Mail all the files to the AVT support [support@alliedvisiontec.com](mailto:support@alliedvisiontec.com) with a detailed description of the problem including:
  - Camera model name.
  - Camera serial number.
  - Type of Power Supply used (AVT or own).
  - Used operating system, 32 or 64 bit edition.
  - Used Pleora driver/SDK version.
  - Used application version (AcquireControl, ...).
  - If possible, open the terminal window in AcquireControl for the following commands (please note the capital letters for the commands!). Enter Y=1. Press RETURN. Enter V=1. Press RETURN. Click **Copy** and paste the output into a text file.
  - If you use AcquireControl >= V3.6.1 click on Help ? Generate Support file and send us the file.



# Appendix

## GigE Vision register description

### Note

This chapter describes all GigE Vision features. In dependence of the camera the availability of certain features may vary.



### DeviceInformation

Feature	Description
DeviceModeName	Name of the attached camera model.
DeviceID	Unique 32 bit device ID of the AVT camera model.
DeviceUserID	User ID field. This field can be accessed (R/W) by the user to store an additional device identifier.
DeviceScanType	This feature specifies the scan type of the sensor (Areascan or Linescan).

Table 5: Standard: DeviceInformation

## ImageSizeControl

Feature	Description
SensorWidth	Maximum width of the sensor in pixels.
SensorHeight	Maximum height of the sensor in pixels.
WidthMax	This feature represents the maximum width (in pixels) of the image after horizontal binning, decimation or any other function changing the horizontal dimensions of the image.
HeightMax	This feature represents the maximum height (in pixels) of the image after vertical binning, decimation or any other function changing the vertical dimensions of the image.
Width	This feature represents the actual image width expelled by the camera (in pixels).
Height	This feature represents the actual image height expelled by the camera (in pixels).
OffsetX	This feature represents the horizontal offset from the origin to the AOI (in pixels).
OffsetY	This feature represents the vertical offset from the origin to the AOI (in pixels).
BinningHorizontal	Number of <b>horizontal</b> pixels to combine together. This increases the intensity (or signal-to-noise ratio) of the pixels and reduces the <b>horizontal</b> resolution ( <b>width</b> ) of the image.
BinningVertical	Number of <b>vertical</b> pixels to combine together. This increases the intensity (or signal-to-noise ratio) of the pixels and reduces the <b>vertical</b> resolution ( <b>height</b> ) of the image.
DecimationHorizontal	Unused.
DecimationVertical	Unused.
PixelFormat	List with all available pixel formats of the camera, e.g. MONO12.
TestImageSelector	Enables or disables the internal test image generator of the camera.
HighSpeedMode	Turn on or off the high-speed mode with reduced resolution.

Table 6: Camera standard feature: ImageSizeControl

## AcquisitionControl

Feature	Description
AcquisitionMode	This feature controls the acquisition mode of the software. This feature works independently (!) of the chosen camera mode (Continuous, IOD hardware trigger, IOD hardware timer). It describes how many frames should be acquired.
AcquisitionStart	Starts the image acquisition of the camera.

Table 7: Camera standard feature: AcquisitionControl

Feature	Description
AcquisitionStop	Stops the image acquisition of the camera.
TriggerMode	Modifies the trigger mode of the camera. When the trigger mode is <b>Off</b> , the camera will generate frames independently. When the trigger mode is <b>On</b> the camera is switched to the so called IOD (Image On Demand) mode. In this mode the camera waits for an external trigger signal or an timer pulse generated internally. To control exposure and dark time trigger mode must be switched to <b>On</b> .
ExposureMode	Start or stop the internal exposure signal timer.
ExposureTime	This feature is used to set the Exposure time (in microseconds).
ExposureTimeAbs	This feature is used to set the Exposure time (in microseconds). Deprecated.
ExposureTimeGranularity	Exposure time granularity
ExposureTimeAbsMs	This feature is used to set the Exposure time (in milliseconds).
DarkTime	This feature is used to set the Dark time (in microseconds).
DarkTimeAbs	This feature is used to set the Dark time (in microseconds). Deprecated.
DarkTimeGranularity	Dark time granularity
DarkTimeAbsMs	This feature is used to set the Dark time (in milliseconds).

Table 7: Camera standard feature: AcquisitionControl

## AnalogControls

Feature	Description
Gain	This feature controls the selected gain as a raw integer value.

Table 8: Camera standard feature: AnalogControls

## CameraSpecialFeatures

What is a CameraSpecialFeature?

This section contains camera depending commands like serial commands (if available). For each command within this branch you will find a description text in your GigE Vision software.

The description contains a reference to the serial command which can be found in the base manual of the camera for further information.

Feature	Description
DigitalGain	Digital Gain Mode (G=<value> command)

Table 9: Camera special feature: DigitalGain

Feature	Description
AutoCalibrateOnce	Start the automatic calibration once. (k=0 command) The processing of this command can take several seconds, depending on the current image rate and the number of correction data sets available.
AutoCalibrationMode	Configure mode of the automatic calibration function. (j=<value> command)
AutoCalibrationInterval	Setup the automatic calibration interval. 0 = Calibrate one-time, 1..65535 = Calibrate every k*256 frames. (k=<value> command)
CorrectionDataSet	Number of the correction data set to activate. (S=<value> command)
ReloadCameraSpecialFeatures	Force a reload of all parameters from the CameraSpecialFeatures section.

Table 10: Camera special feature: Calibration and correction data

Feature	Description
CameraTemperatureState	Camera temperature state. 0 = The camera temperature is OK. 1 = The camera temperature is outside the optimum range.
CameraTemperatureStateReg	Camera temperature state register.
QueryCameraTemperatureState	Query camera temperature state. (T=1 command)

Table 11: Camera special feature: Camera temperature

Feature	Description
SensorTemperatureState	Camera sensor temperature state. 0 = The sensor temperature is OK. 1 = The sensor temperature is outside the optimum range.
SensorTemperatureStateReg	Camera sensor temperature state register.
QuerySensorTemperatureState	Query camera sensor temperature state. (T=1 command)

Table 12: Camera special feature: Camera sensor temperature

Feature	Description
ShutterTemperatureValue	Shutter temperature value in degree Celsius.
ShutterTemperatureValueReg	Shutter temperature value register.
QueryShutterTemperatureValue	Query camera shutter temperature state. (T=2 command)
MechanicalShutter	Set the mechanical shutter state manually. (I=<value> command)

Table 13: Camera special feature: Shutter

## CameraSpecialFeatures\TwoPointCorrection

Feature	Description
TPC_OperationMode	Operation mode of the two-point correction. (E=<value> command)
TPC_CorrectionData_FileNumber	File number of the flash file containing the set values for the two-point correction. (N=<value> command)
TPC_SetValue_LowRef	Define the set value for the <b>low</b> reference image of the two-point correction. (J=<value> command)
TPC_SetValue_HighRef	Define the set value for the <b>high</b> reference image of the two-point correction. (K=<value> command)
TPC_FirstImage_LowRef	File number of the first <b>low</b> reference image of the two-point correction. (A=<value> command).
TPC_FirstImage_HighRef	File number of the first <b>high</b> reference image of the two-point correction. (B=<value> command).

Table 14: Camera special feature: TwoPointCorrection

## CameraSpecialFeatures\BackgroundCorrection

Feature	Description
BGC_OperationMode	Operation mode of the background correction. (U=<value> command)  While reading this feature the MSB shows the state of the integration process. (0=Idle, 1=Busy)
BGC_OffsetValue	Offset value for the background correction. (M=<value> command)
BGC_StartIntegration_1	Save the next frame as background image. (I=0 command)
BGC_StartIntegration_4	Integrate the next 4 frames and store the result as background image. (I=1 command)

Table 15: Camera special feature: BackgroundCorrection

### CameraSpecialFeatures\LUT

Feature	Description
LUT_OperationMode	Operation mode of the LUT. (G=<value> command)
LUT_CorrectionData_FileNumber	File number of the data for the LUT. (D=<value> command)

Table 16: Camera special feature: LUT

### CameraSpecialFeatures\IntegratorAndImageStore

Feature	Description
IIS_OperationMode	Operation mode of the integrator and image store. (H=<value> command)  While reading this feature the MSB shows the state of the integration process. (0=Idle, 1=Busy)

Table 17: Camera special feature: IntegratorAndImageStore

### CameraSpecialFeatures\BadPixelCorrection

Feature	Description
BPC_OperationMode	Operation mode of the bad pixel correction. (F=<value> command)
BPC_CorrectionData_FileNumber	File number of the correction data for the bad pixel correction. (C=<value> command)

Table 18: Camera special feature: BadPixelCorrection

## GigE Vision timer calculations

The figure below shows how an exposure signal is generated.

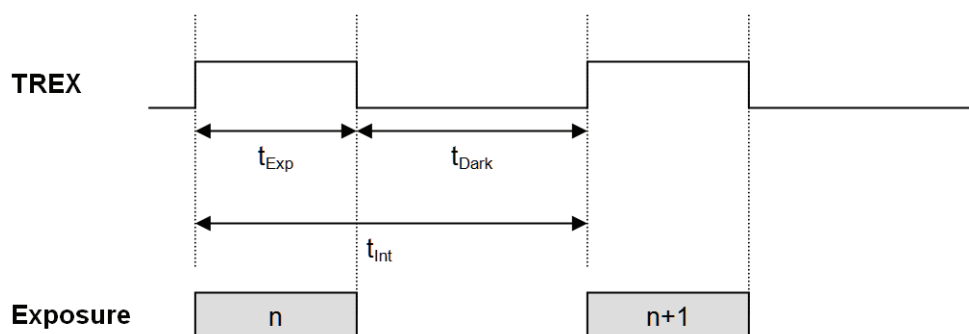

$t_{Exp}$  = Exposure time  
 $t_{Dark}$  = Dark time  
 $t_{Int}$  = Interval time = 1 / Frame rate

Figure 28: GigE Vision timer calculations

In order to adjust  $t_{Exp}$  and  $t_{Dark}$  of the TRES pulse in each case two parameters are available:

- ExposureTime & ExposureTimeGranularity
- DarkTime & DarkTimeGranularity

The granularities are integer values in the range from 0...65535 which define the minimum and maximum pulse widths. The minimum pulse width is equal to the time granularity.

$$t_{ExpMIN}(\mu s) = \frac{(ExposureTimeGranularity + 1) \times 30ns}{1000}$$

$$t_{ExpMAX}(\mu s) = \frac{(ExposureTimeGranularity + 1) \times 30ns \times 65535}{1000}$$



## Feature mapping

This table shows the mapping of the camera features to the corresponding features in the GigE Vision naming convention.

AVT camera feature	Camera Link CC port	GigE Vision feature names
TREX	CC1	ExposureMode, ExposureTime, DarkTime  TREX is an input signal. The LOW time defines the exposure time. The HIGH time defines the dark time.
BIN	CC2	BinningVertical. If the camera has 2x2 binning implemented, the BinningHorizontal feature is set automatically.
SV2	CC3	GainRaw
IOD	CC4	TriggerMode

Table 19: Feature mapping

# Index

## A

AcquireControl  
using ..... 20

## B

BinningHorizontal ..... 42  
BinningVertical ..... 42

## C

camera live images ..... 20  
Conformity ..... 10  
Contacting ..... 5

## D

declaration of conformity ..... 10  
DHCP ..... 12  
document history ..... 6

## F

Feature mapping ..... 49

## G

GigE driver from Pleora ..... 18  
GigE Vision register description ..... 41

## I

IP settings ..... 12

## L

LED states ..... 19  
Legal notice ..... 2  
Link Local Address ..... 12  
LLA ..... 12

## S

specifications ..... 18  
Static IP address ..... 13  
Static Persistent IP

GigE Vision cameras ..... 14  
Static Persistent IP address ..... 13  
styles ..... 7  
Support ..... 5  
symbols ..... 7

## T

Technical information ..... 5  
timer calculations ..... 48  
Troubleshooting ..... 39